

Barreling Booster ROLLER COASTER

This model is constructed with Rippin' Rocket Roller Coaster parts.



The frame is built in 5 sections (A-E).

E



A

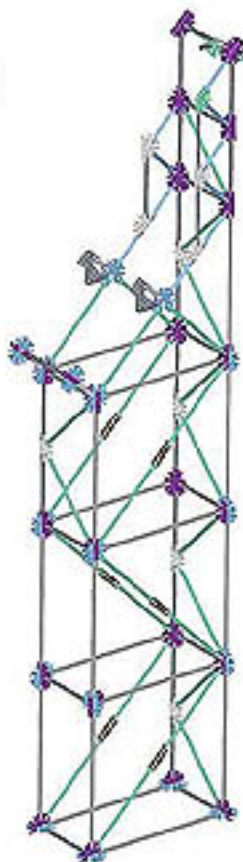

B

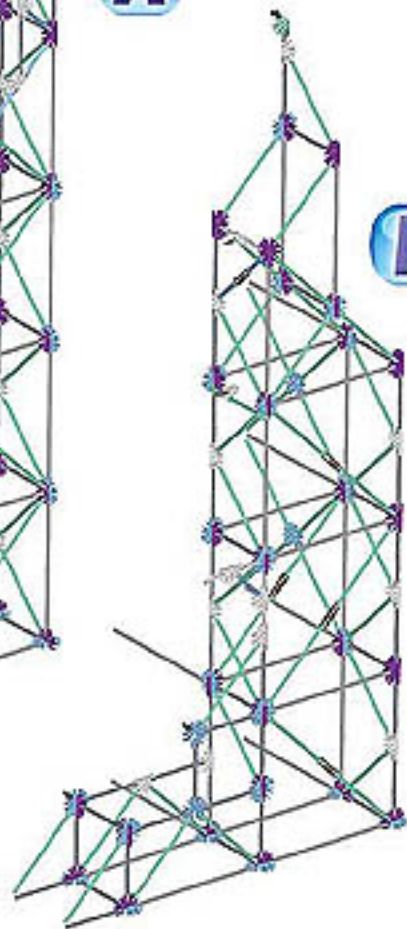

D

E



C

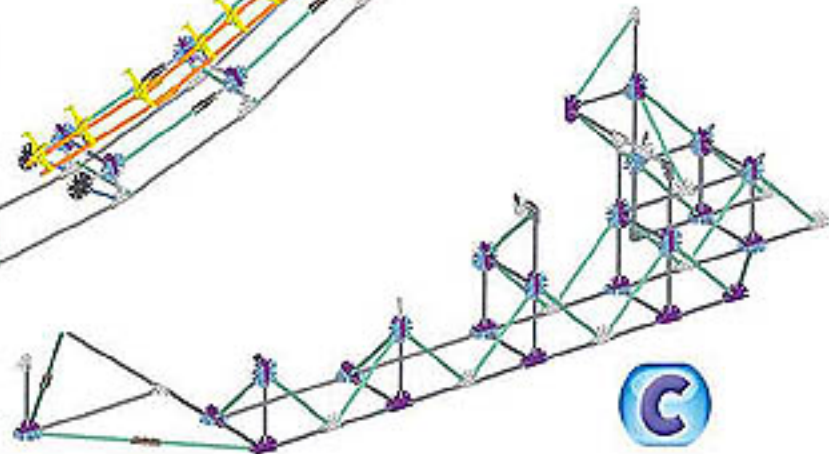

A

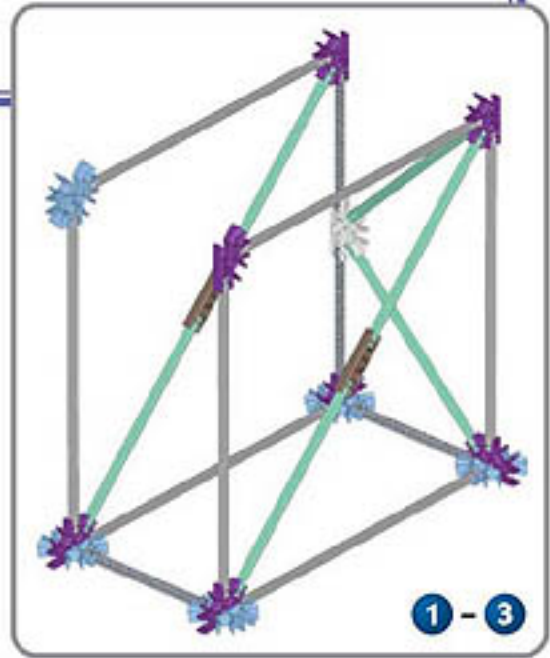
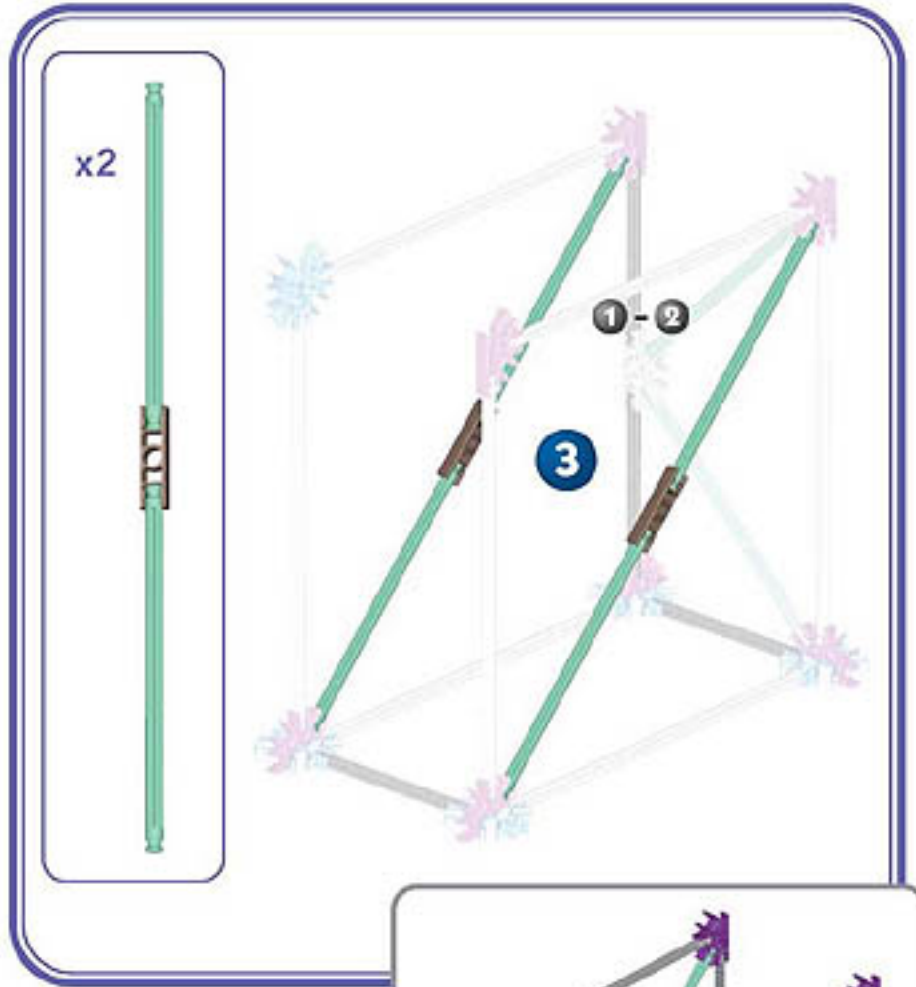
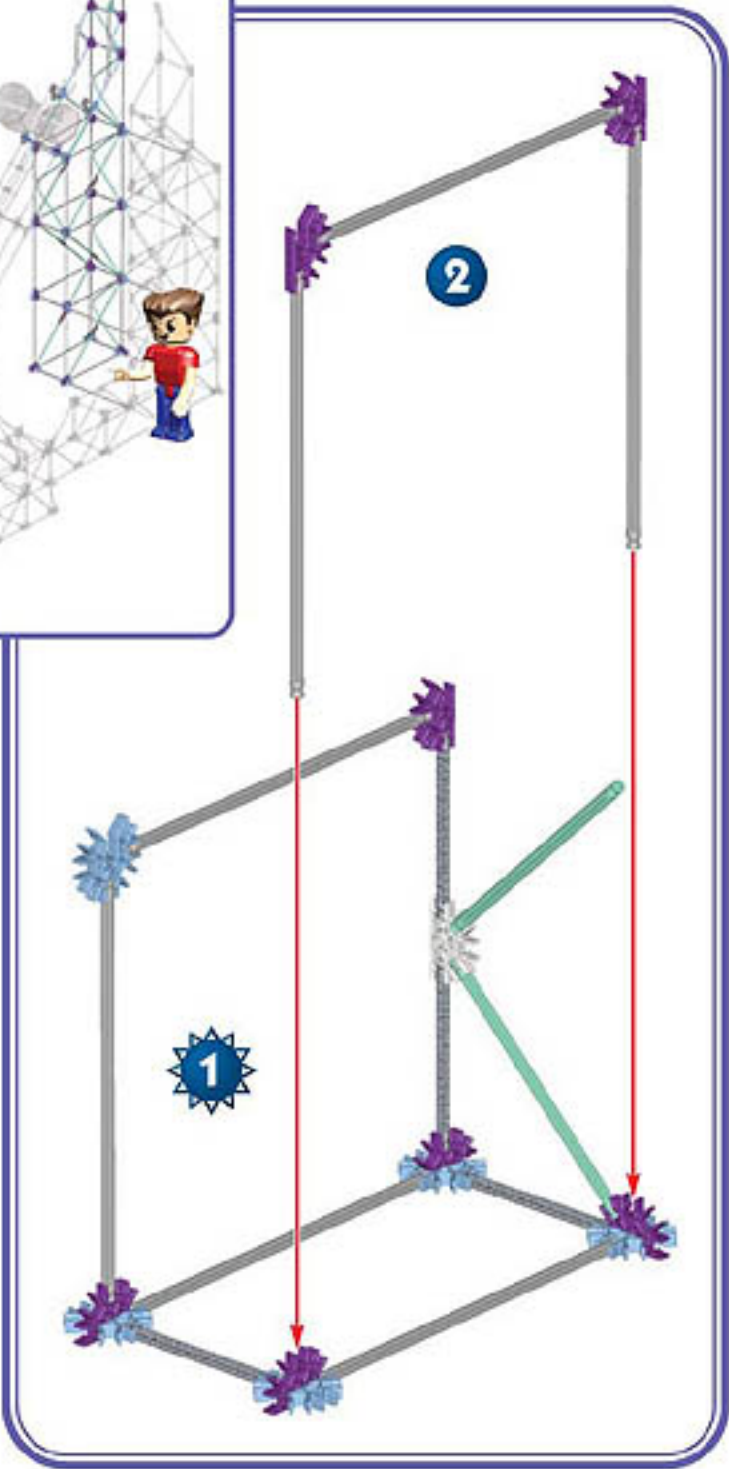
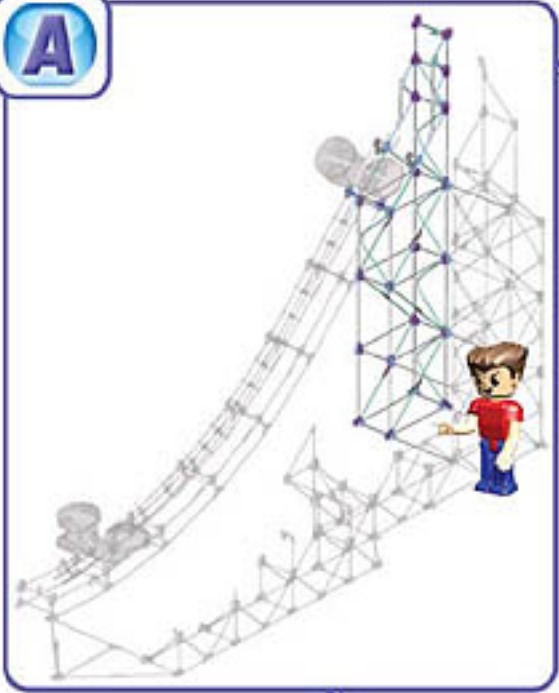

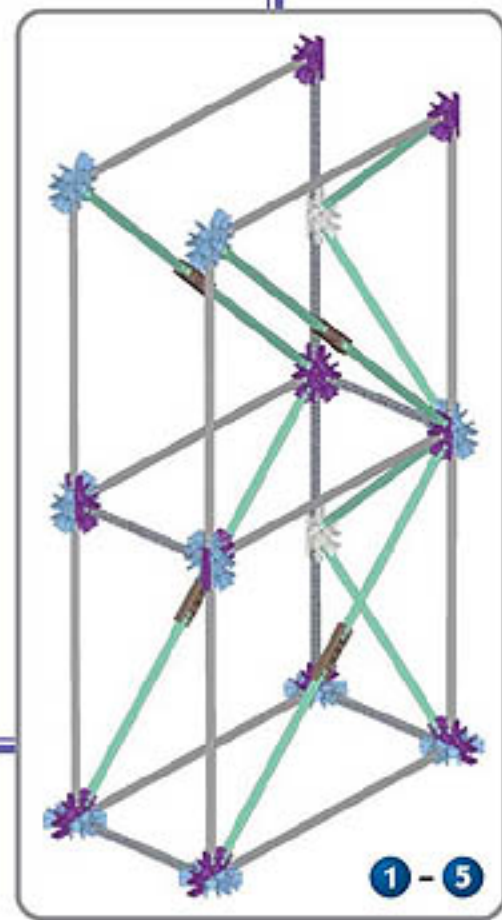
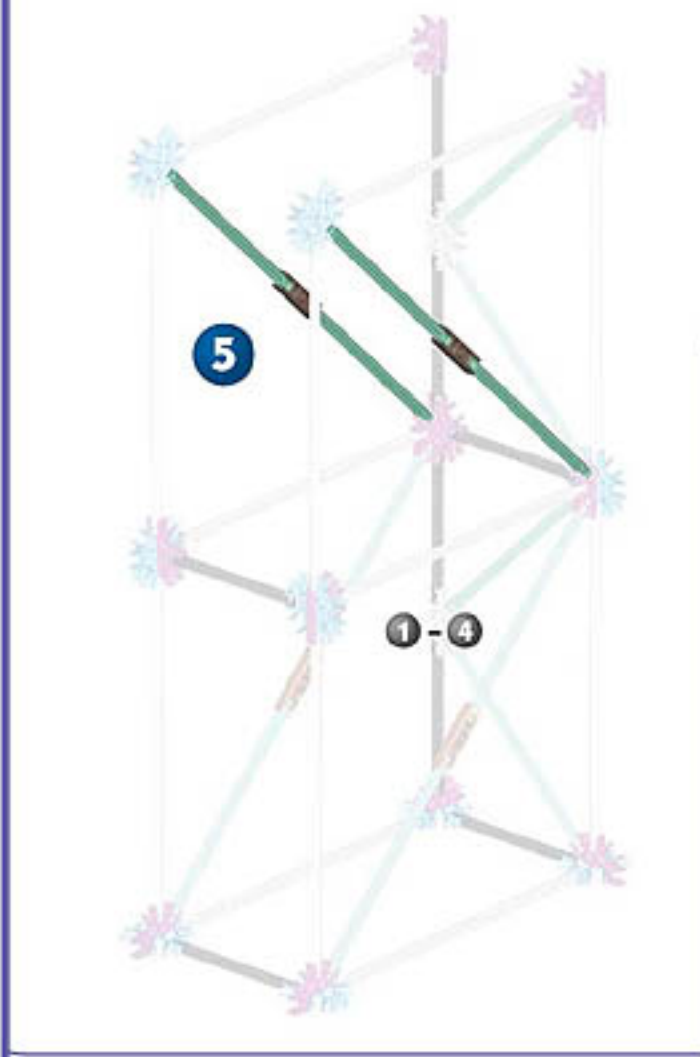
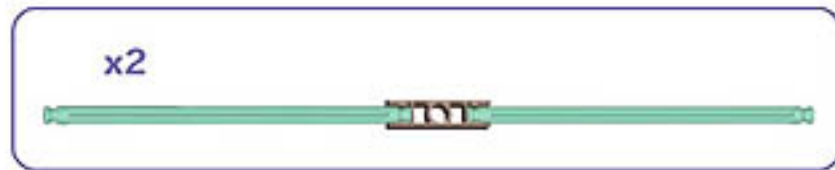
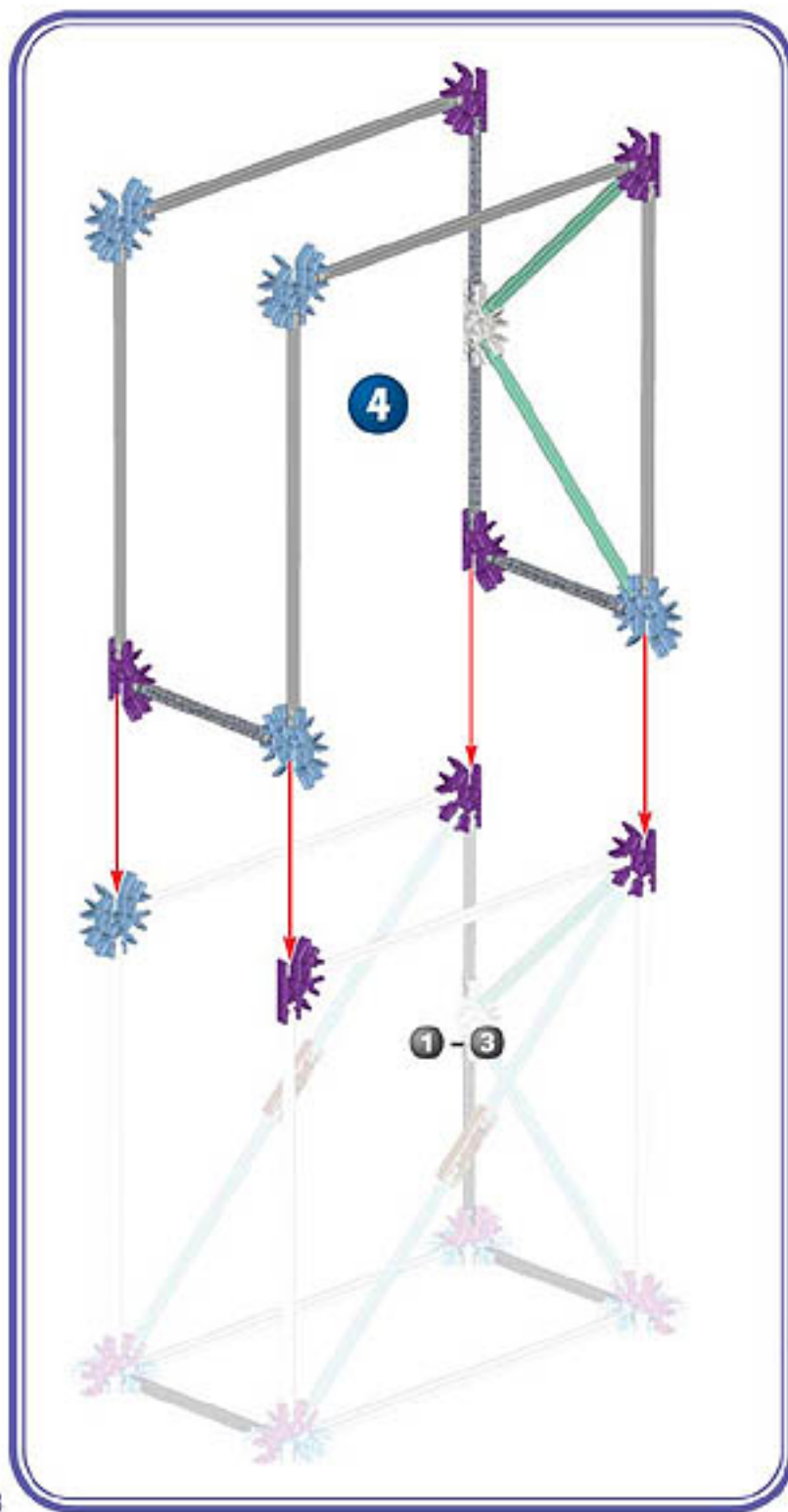

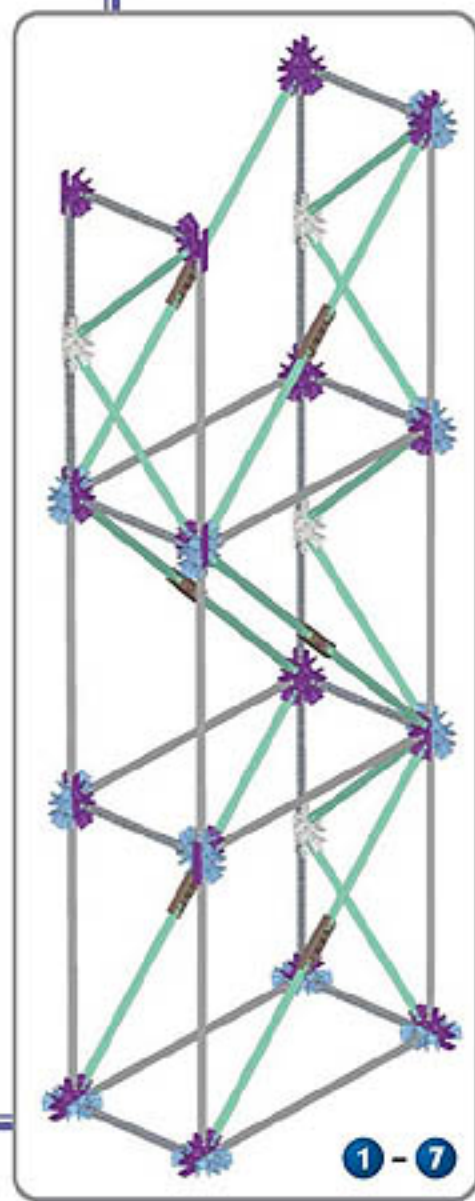
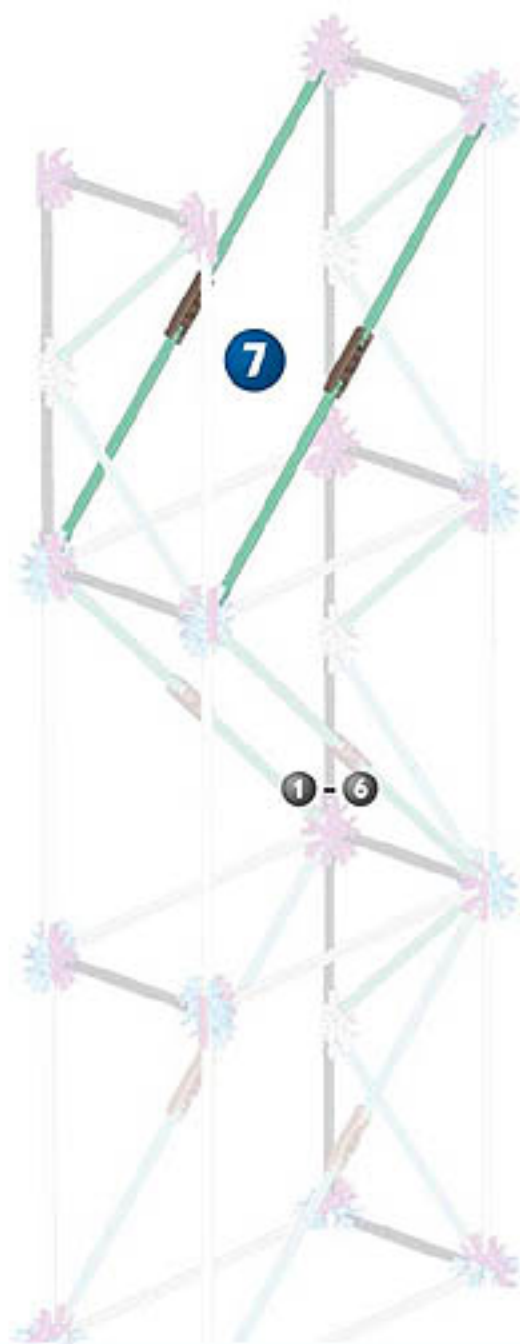
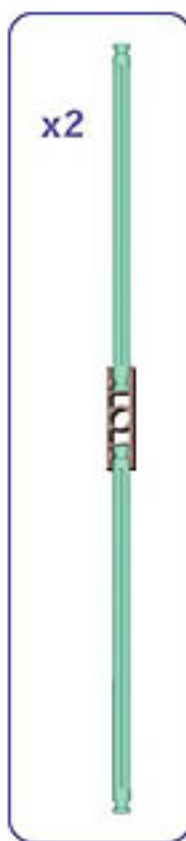
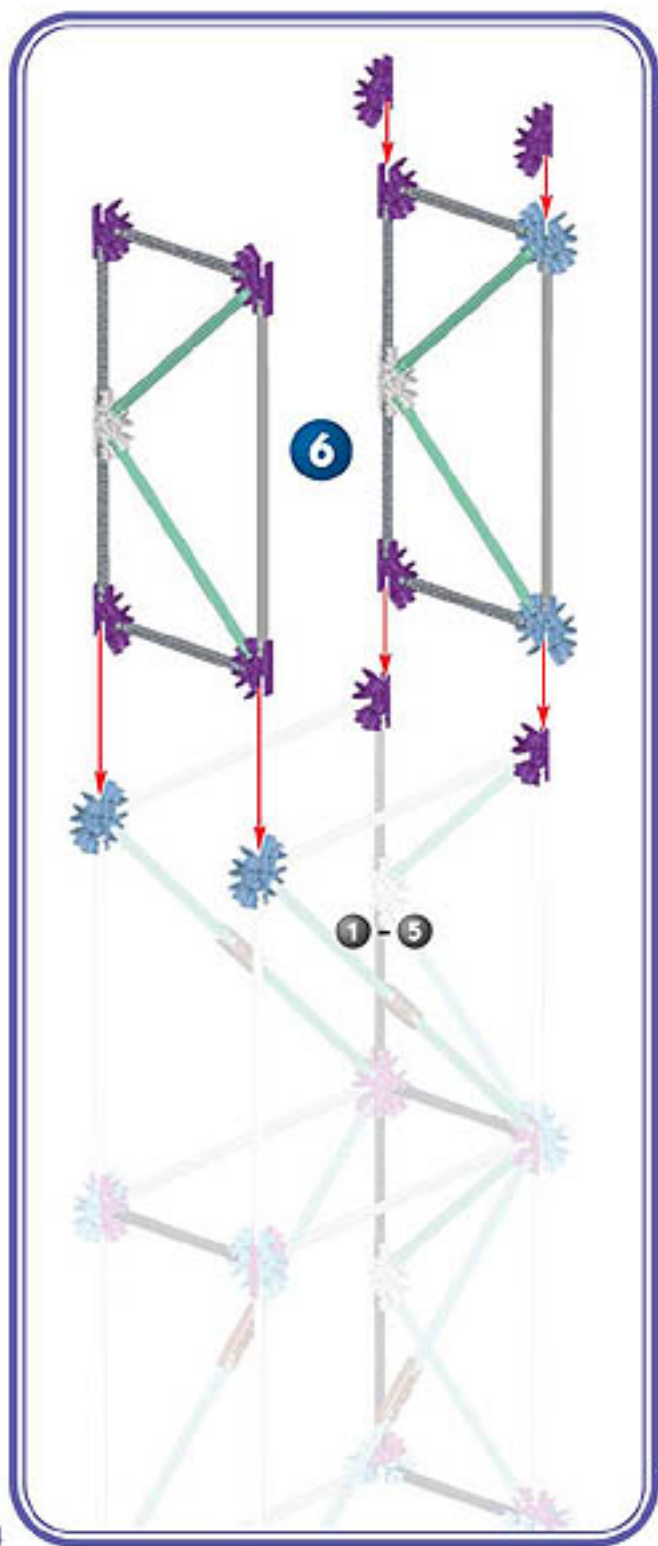

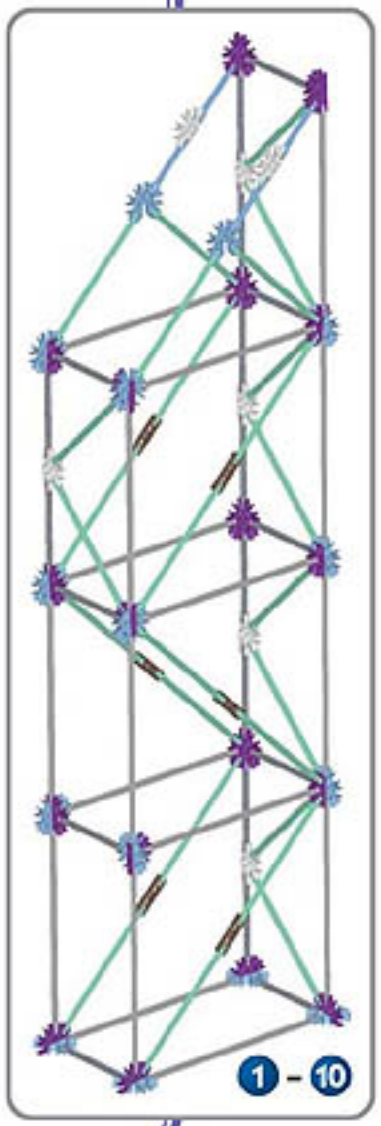
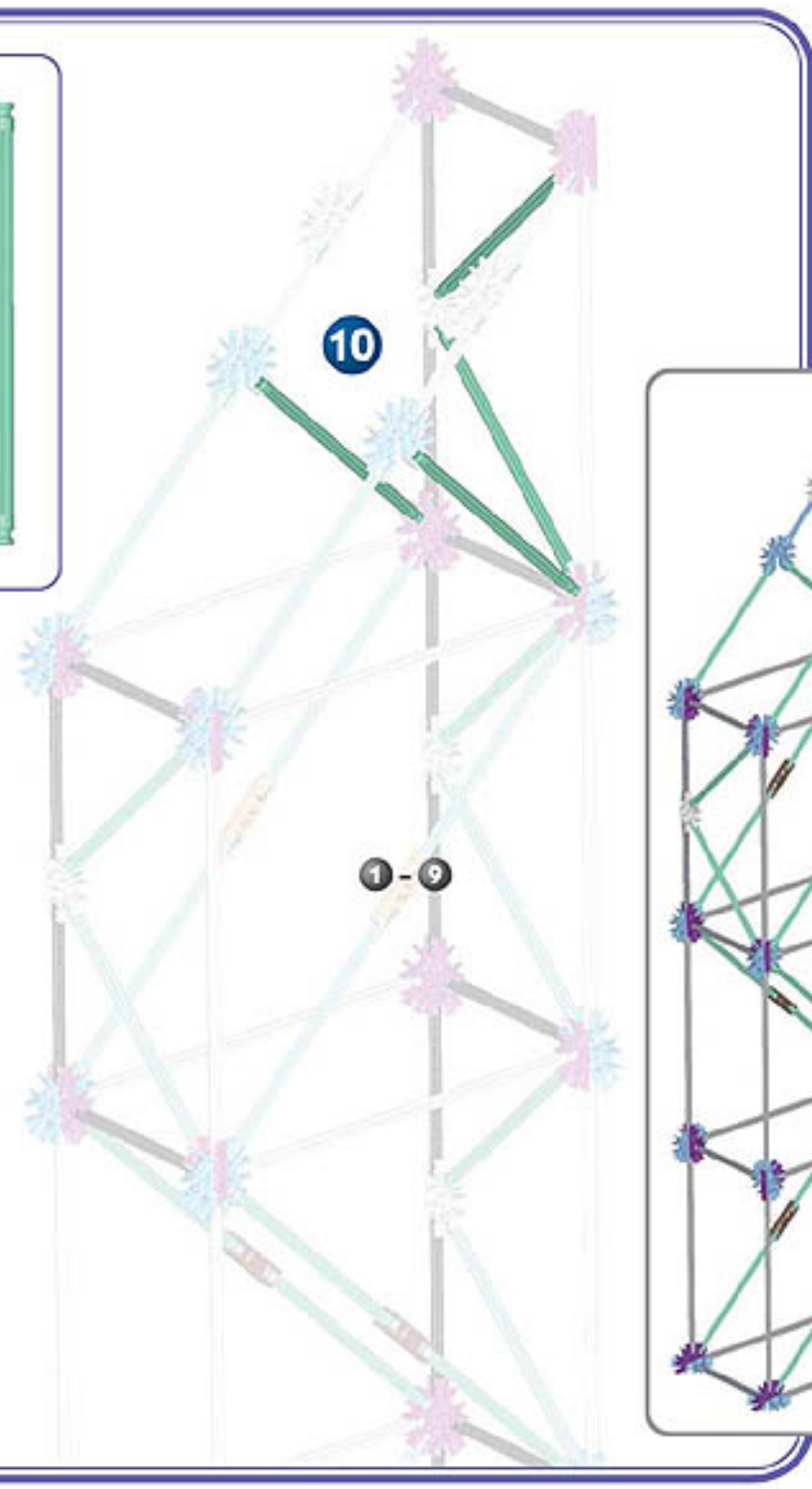
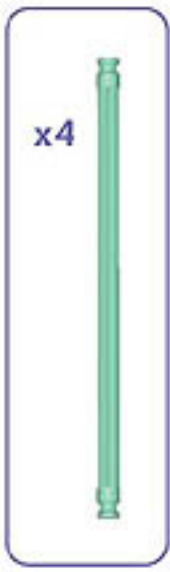
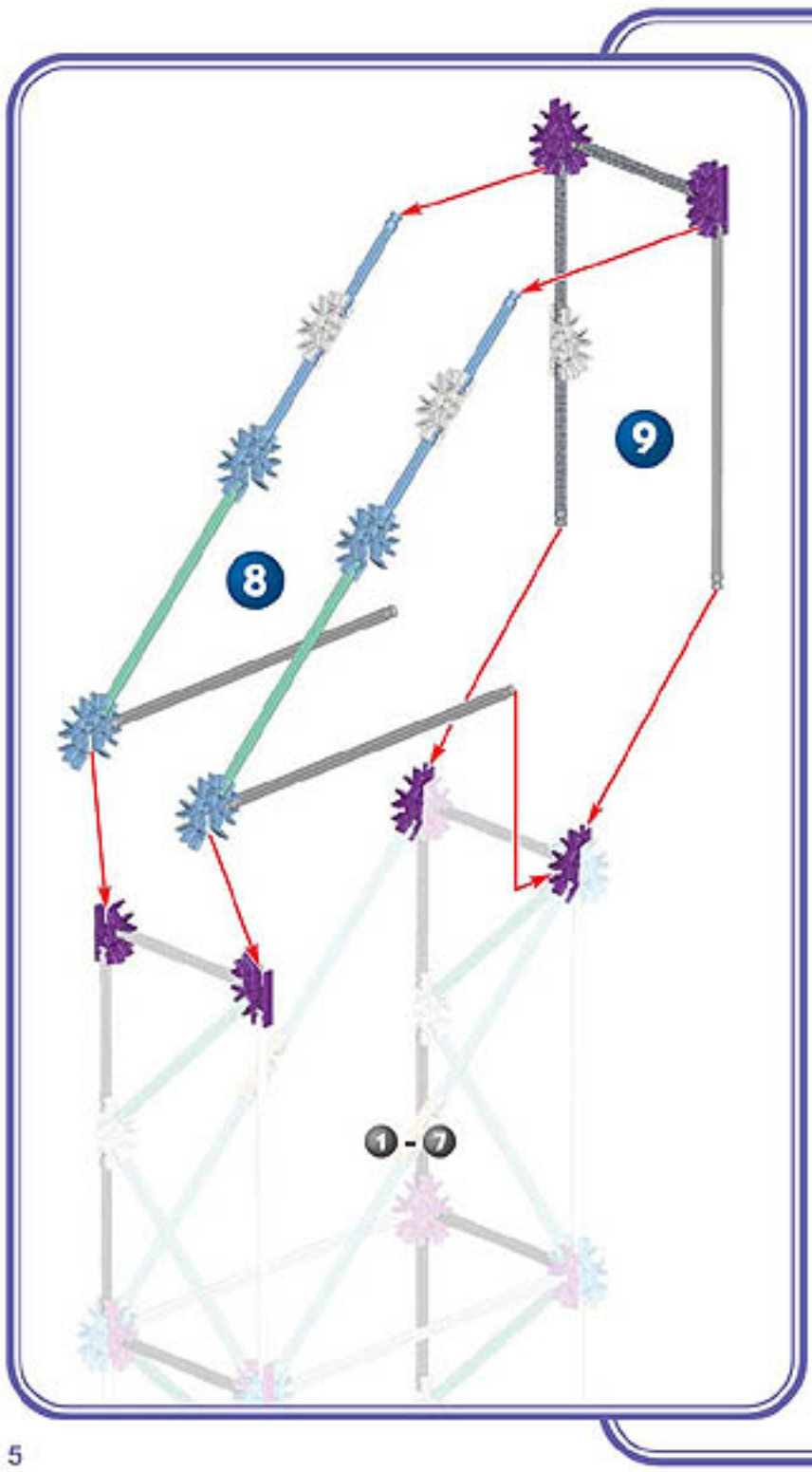

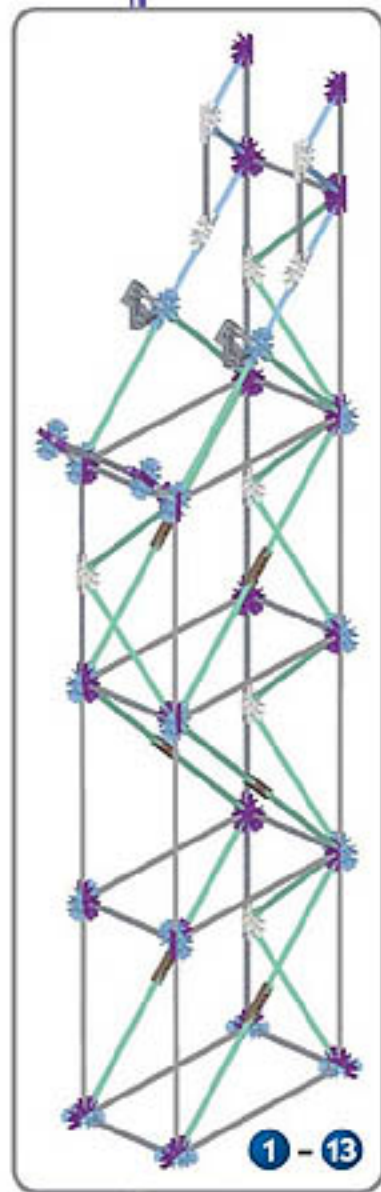
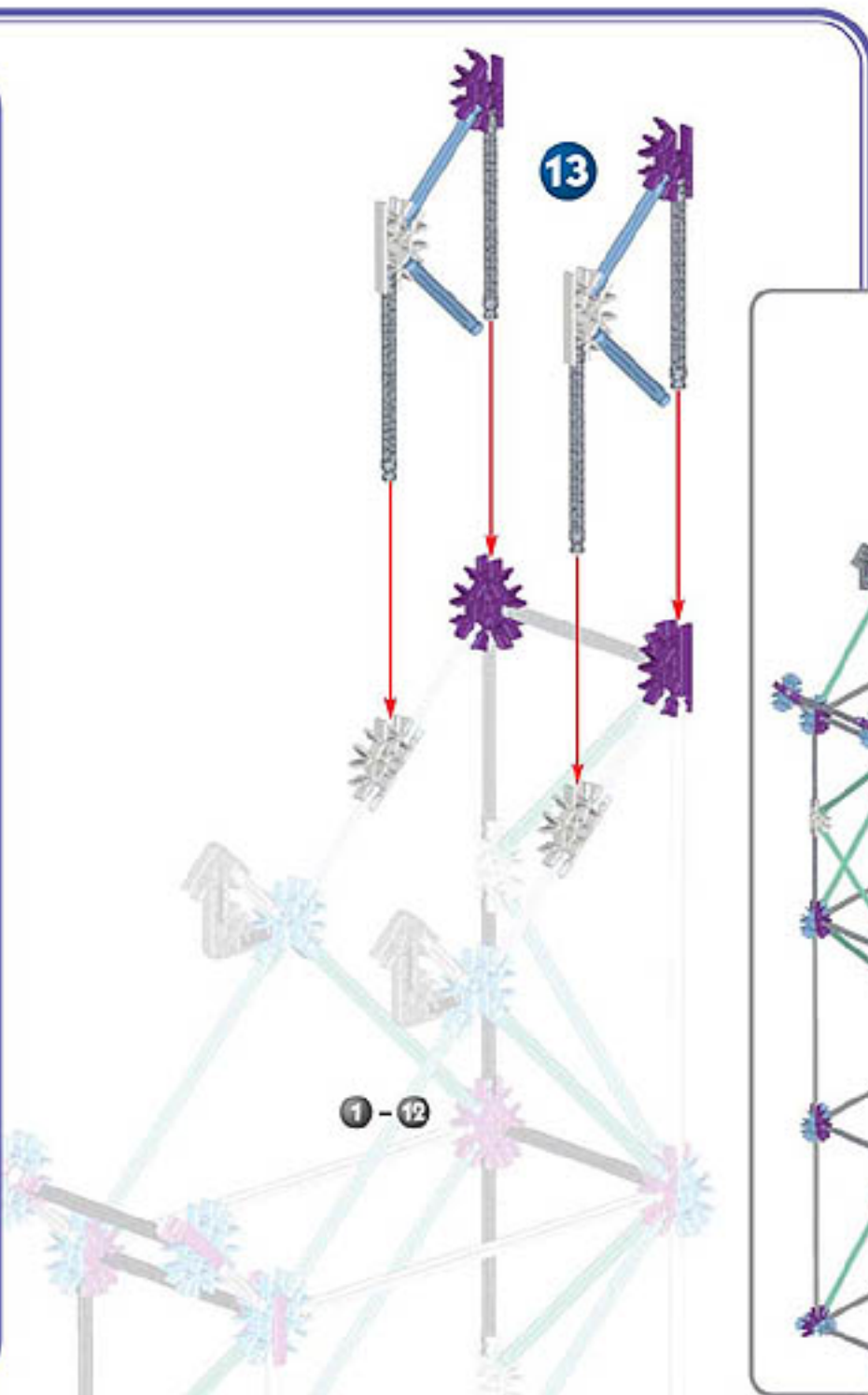
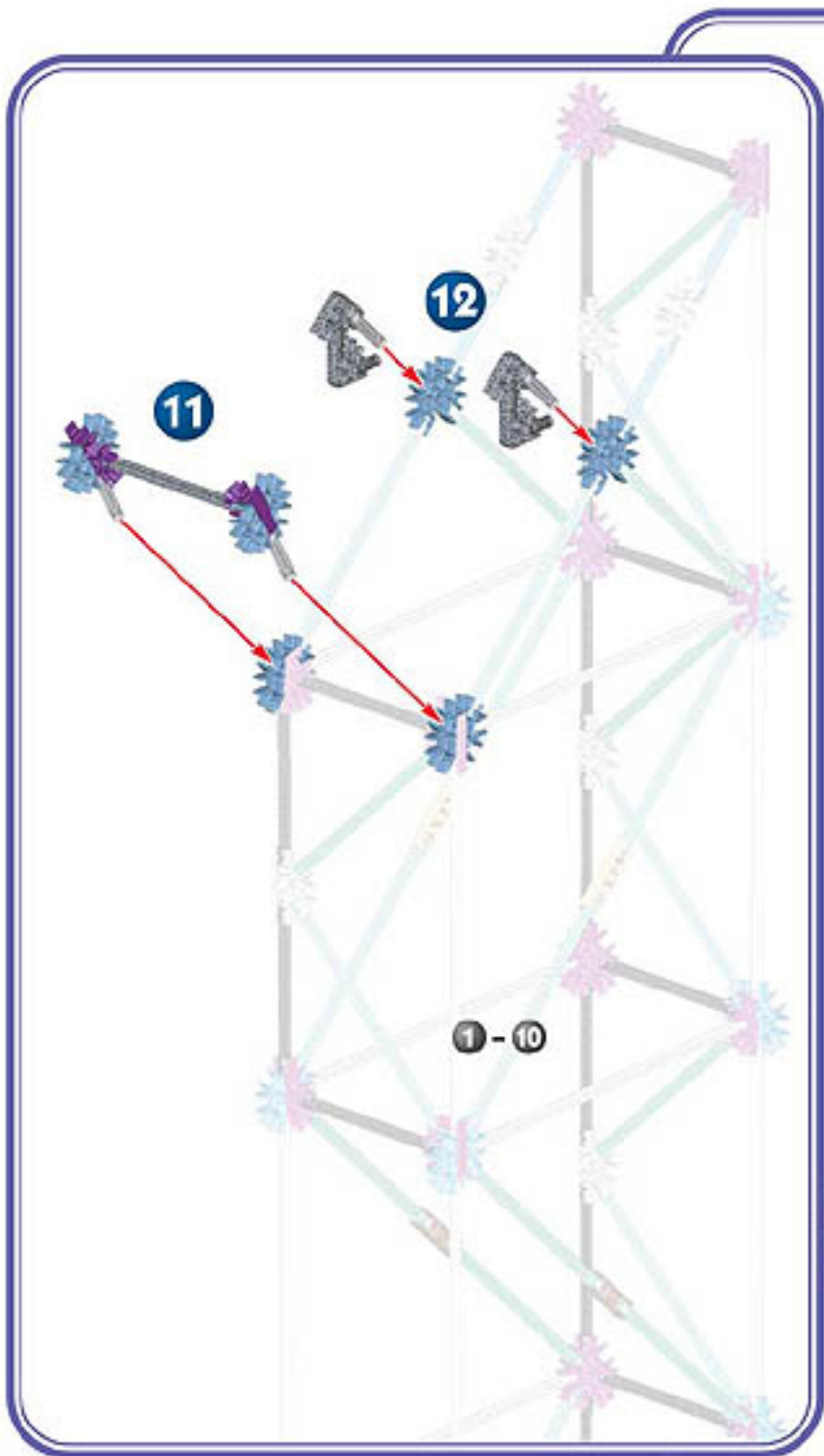

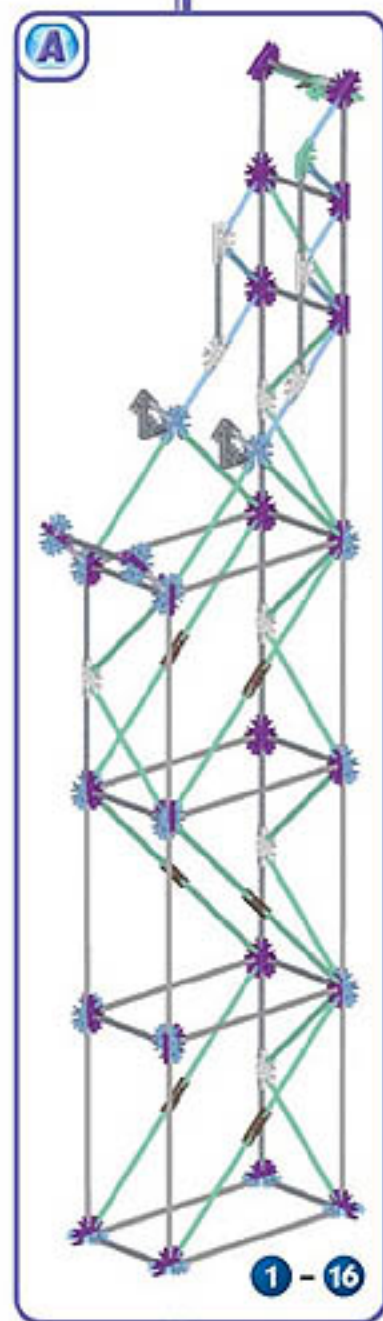
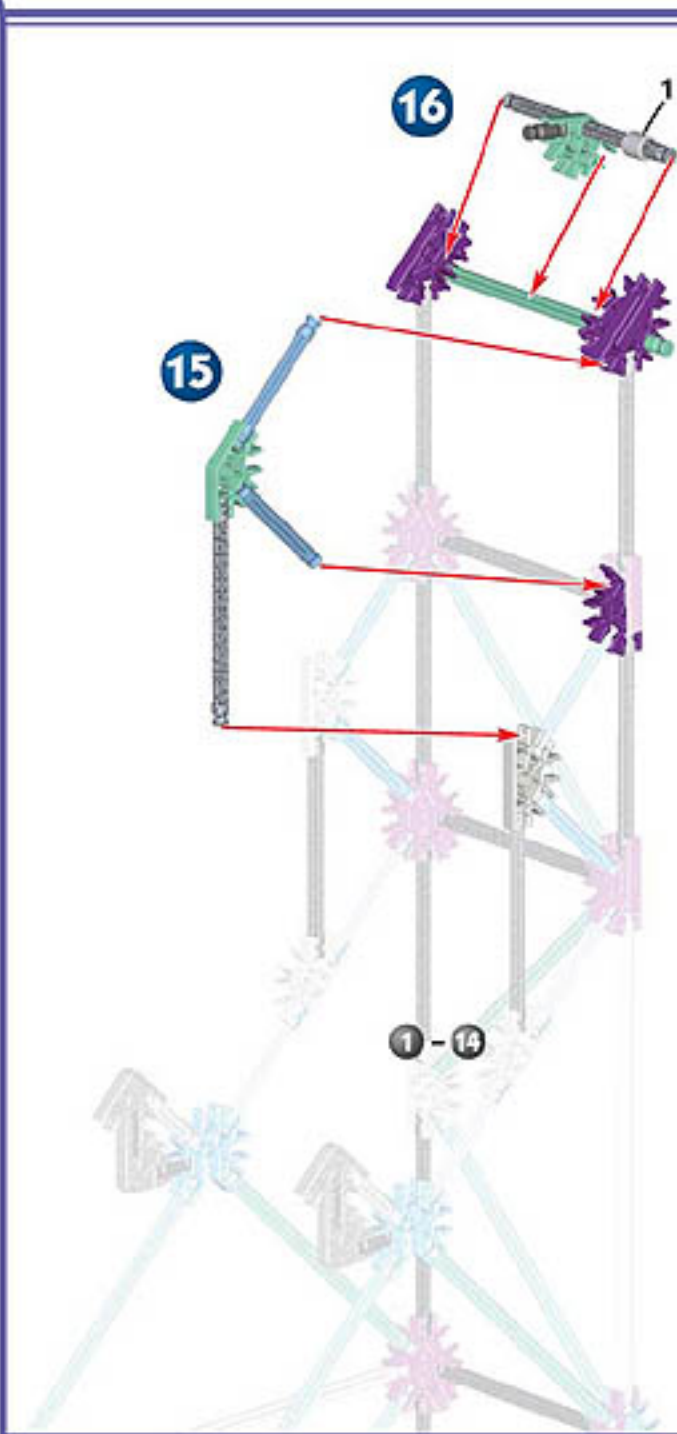
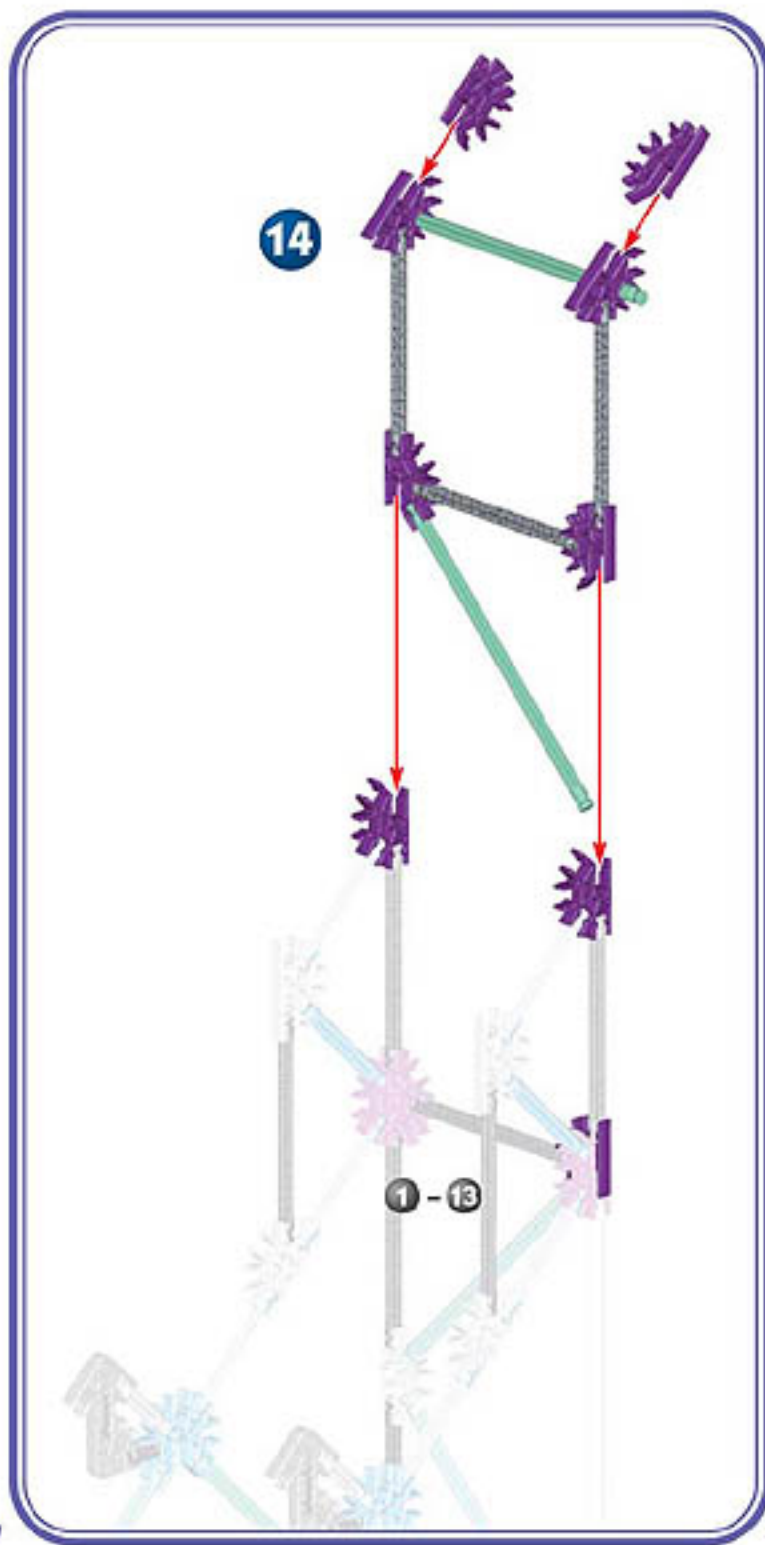

B

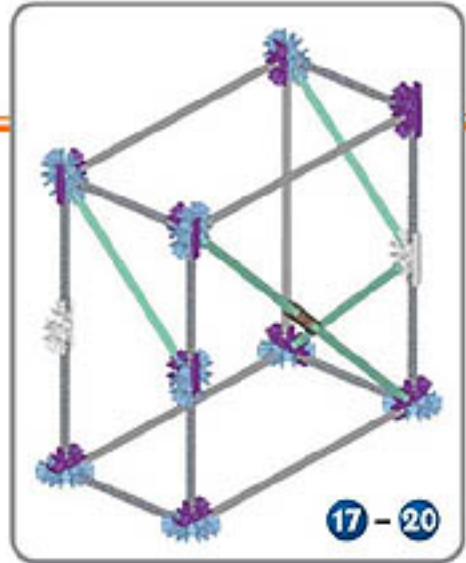
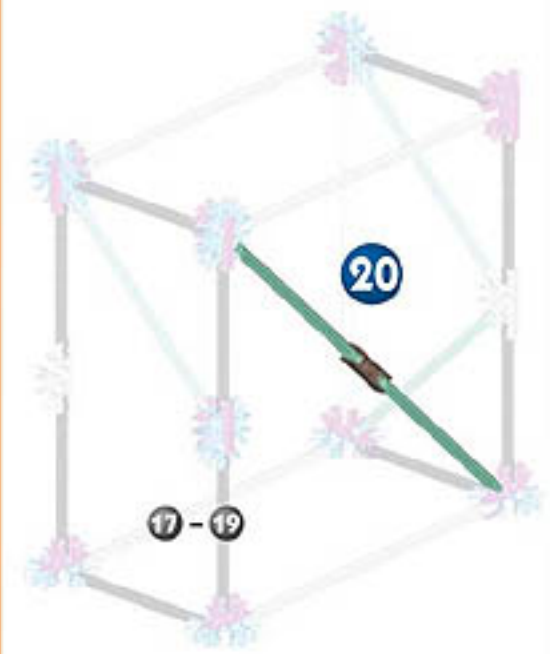
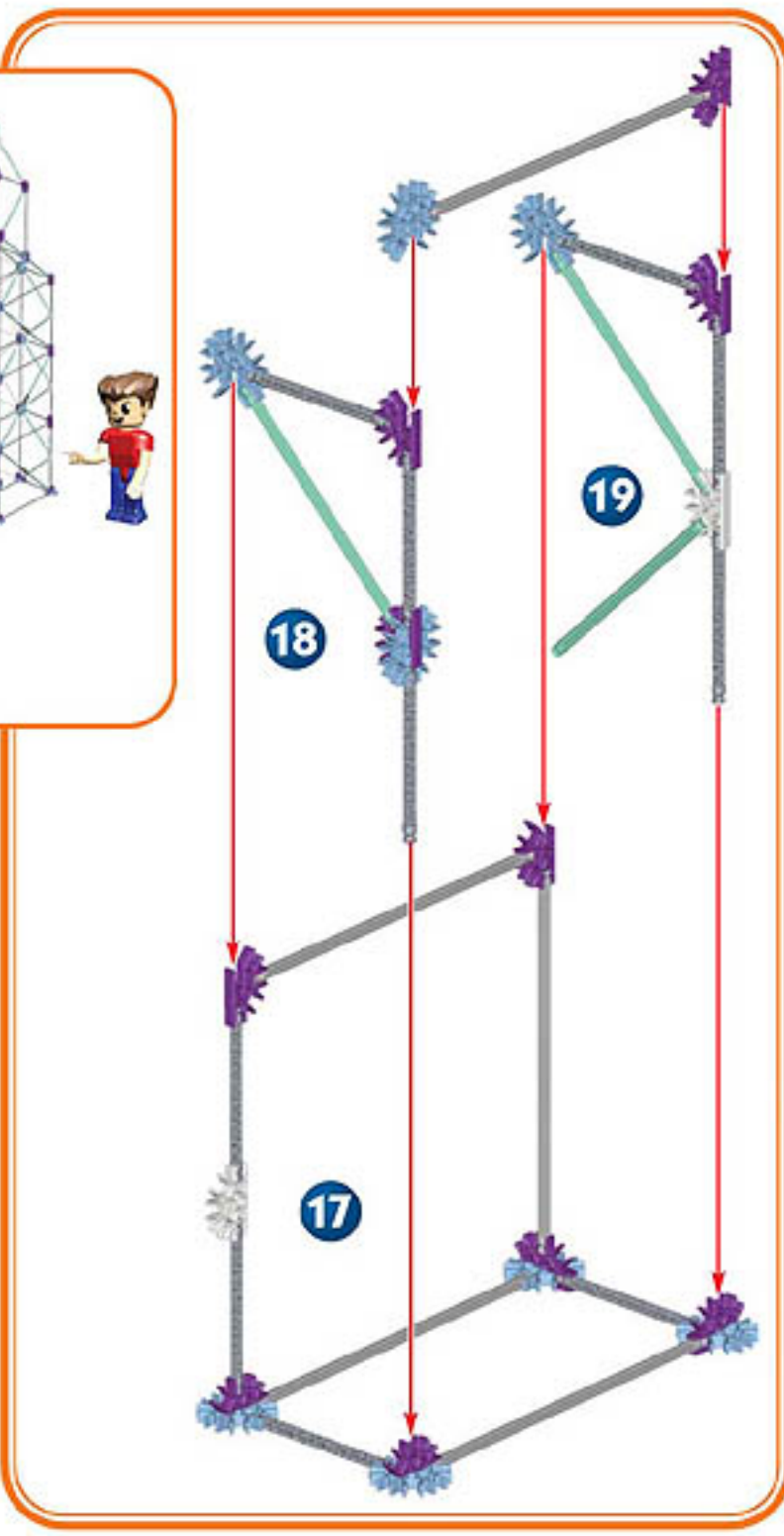
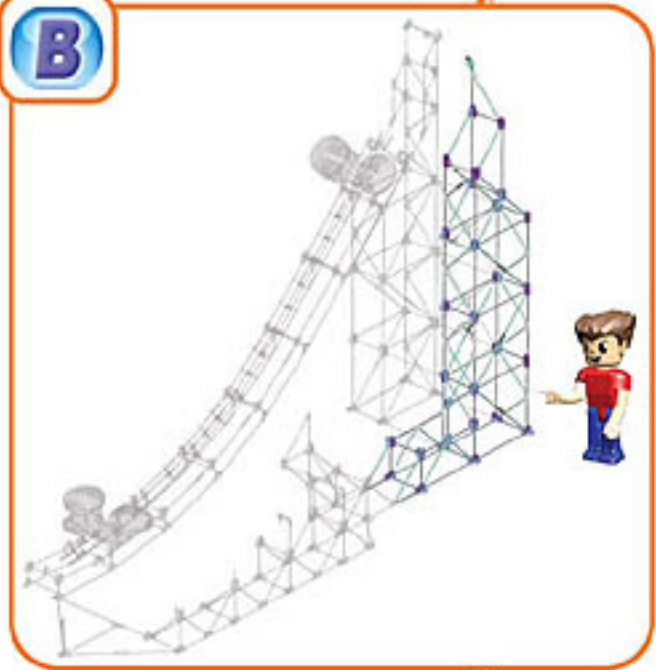

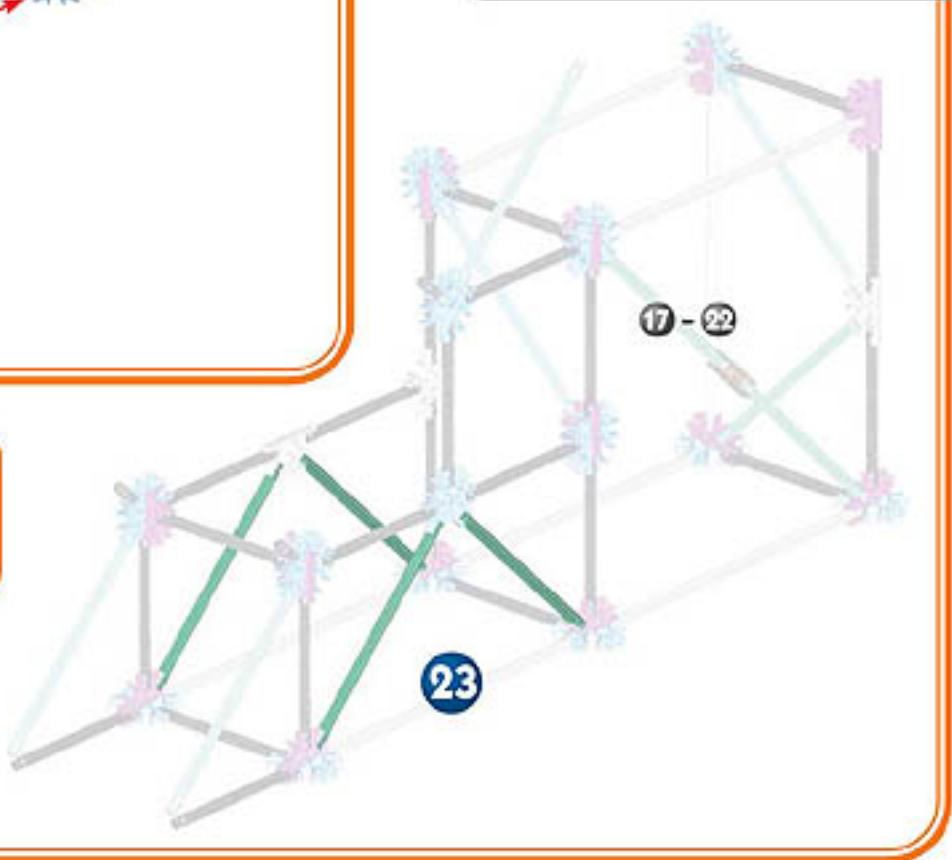
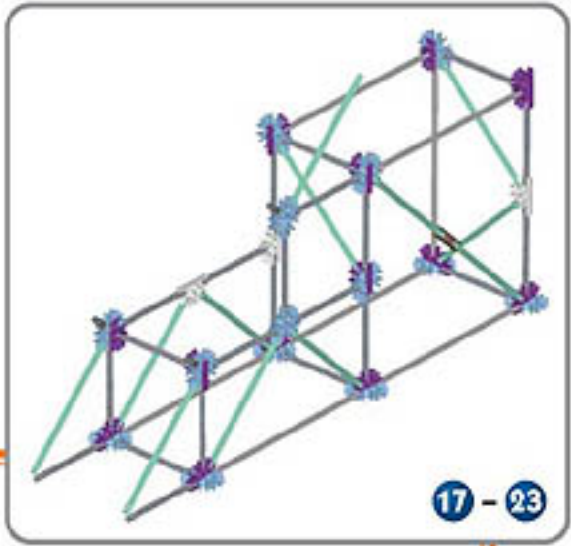
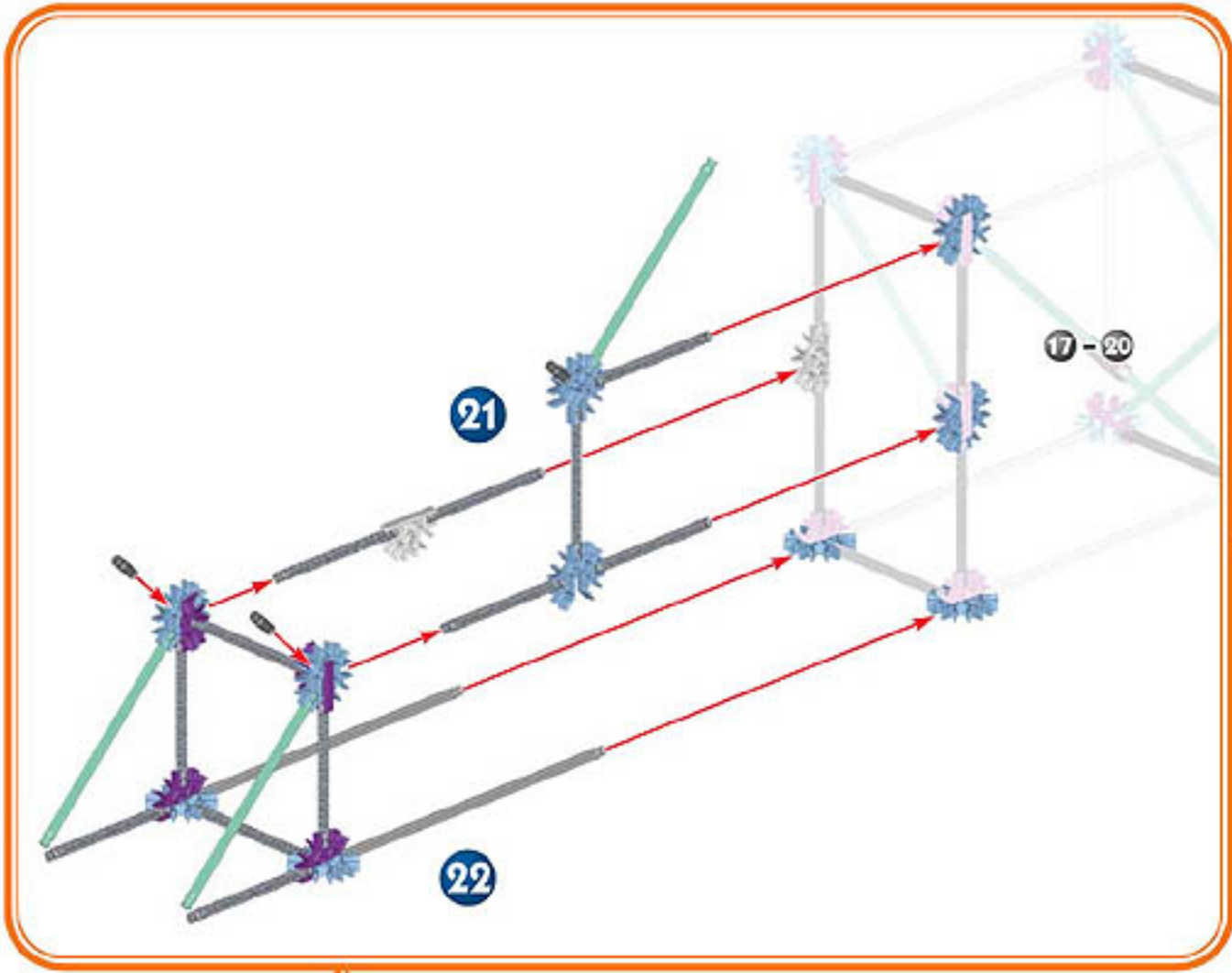

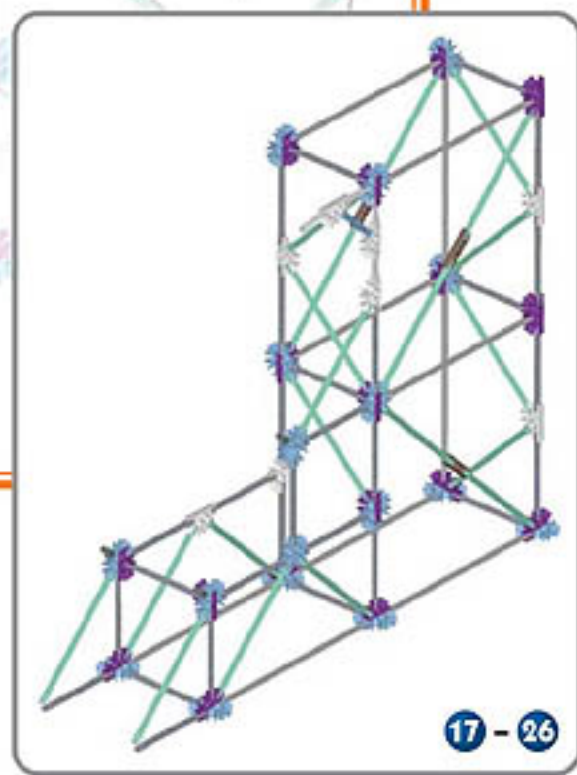
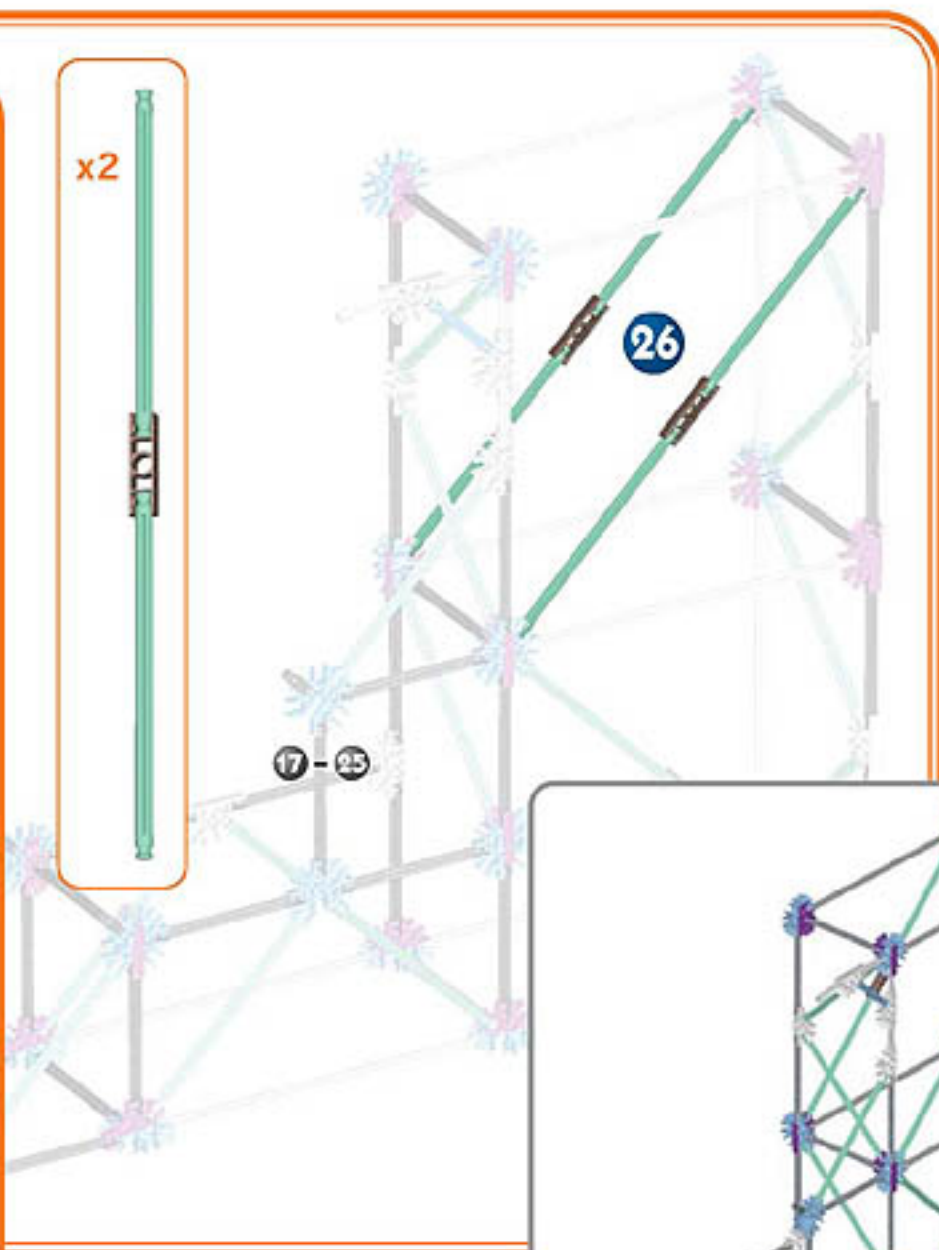
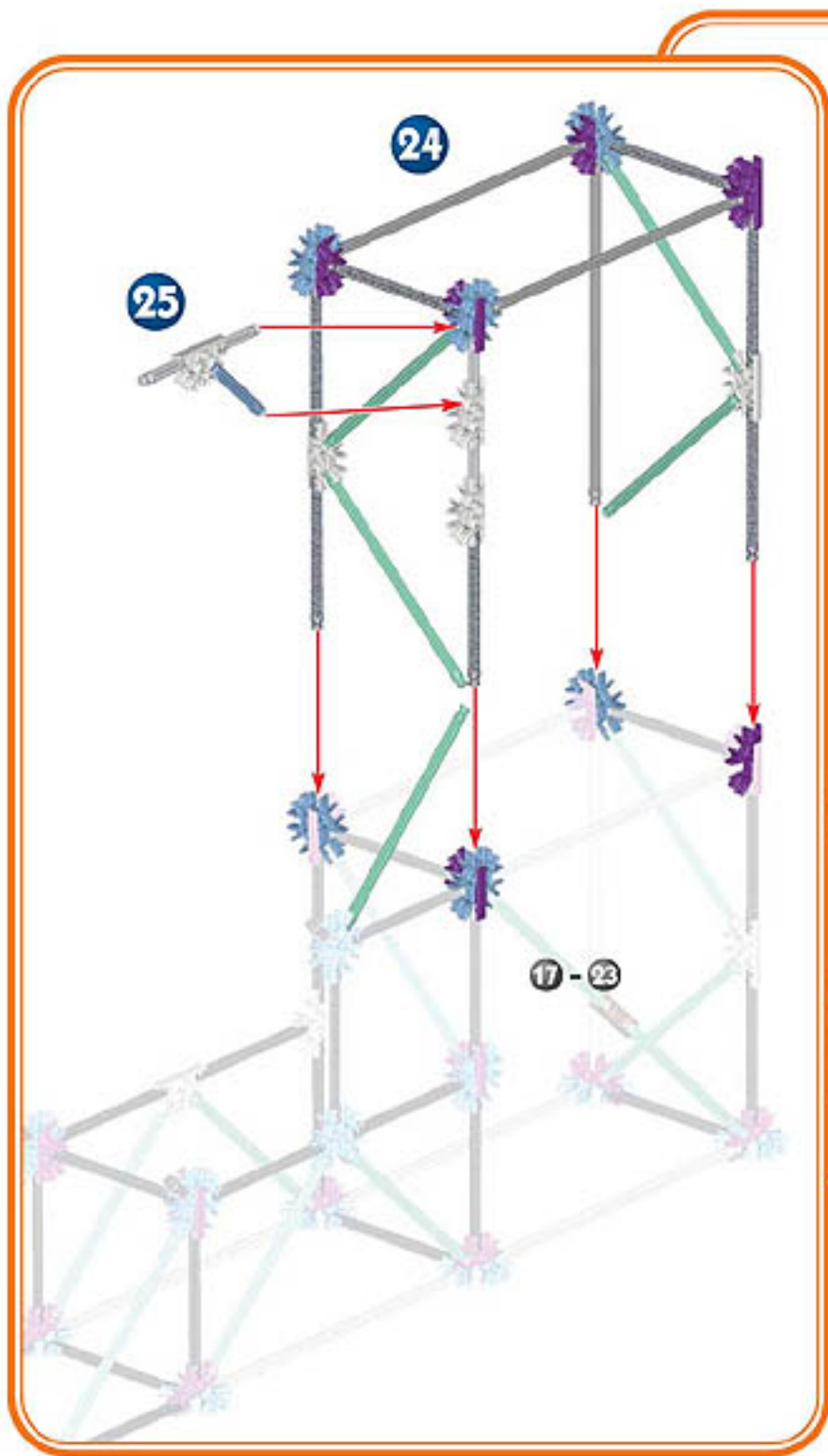

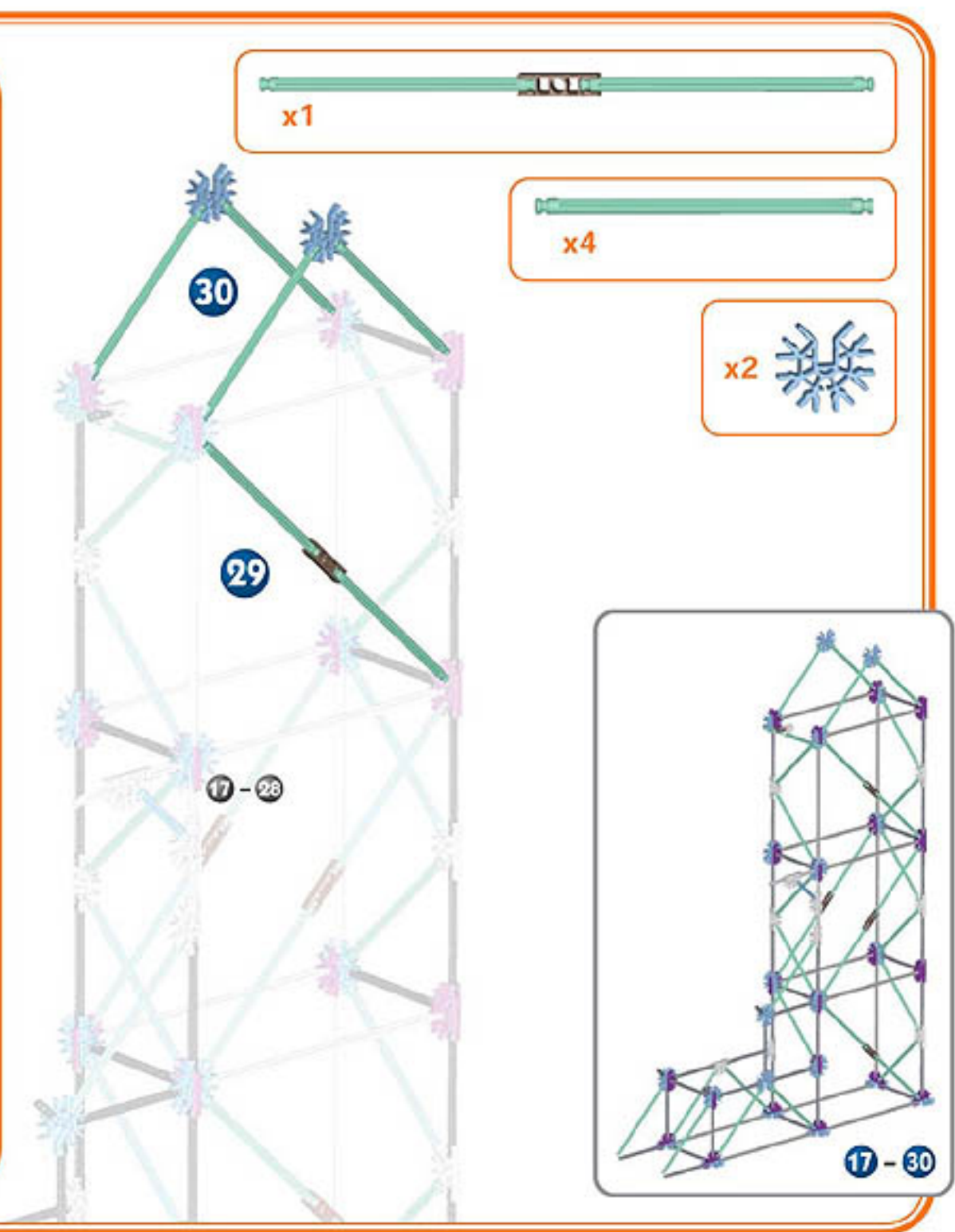
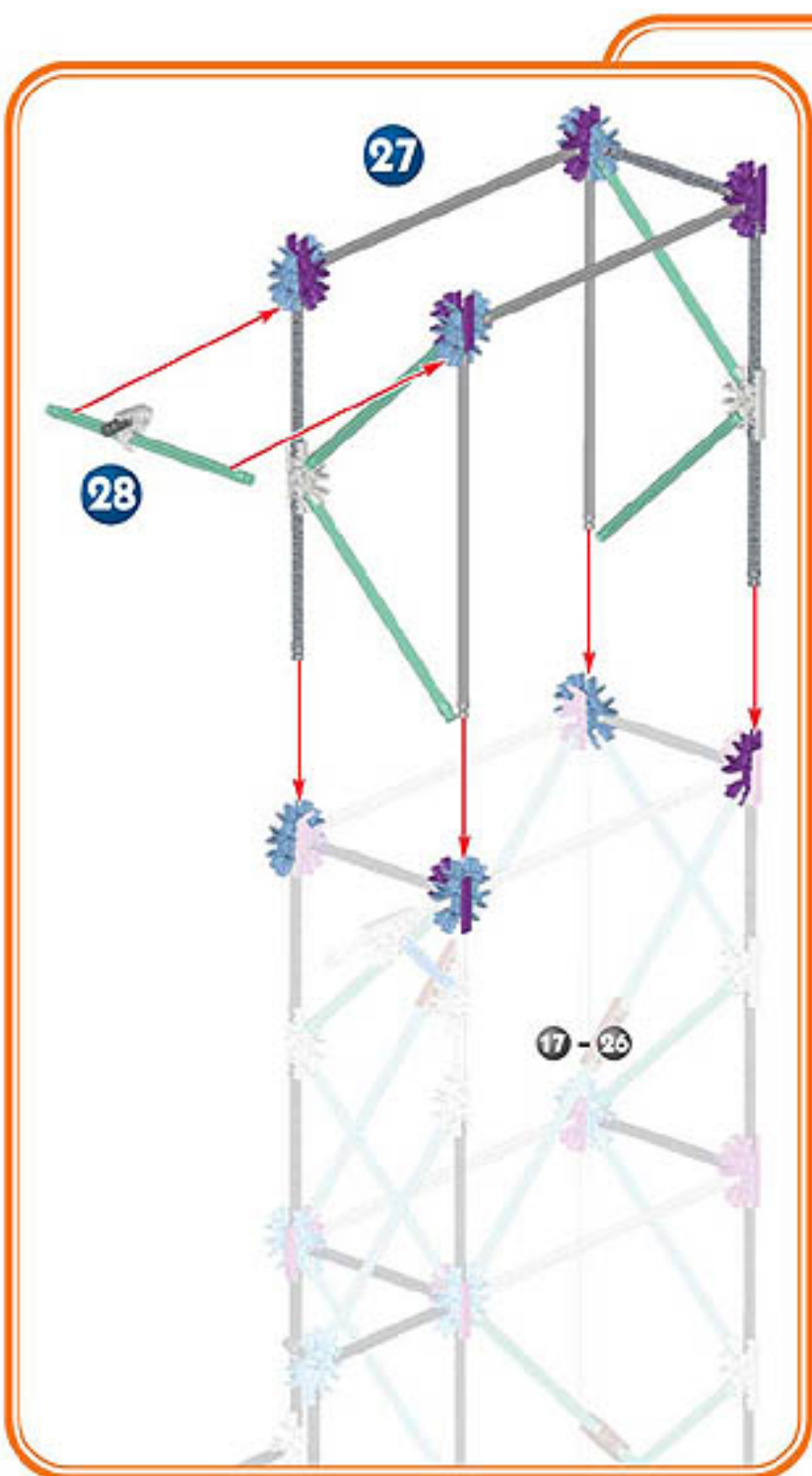

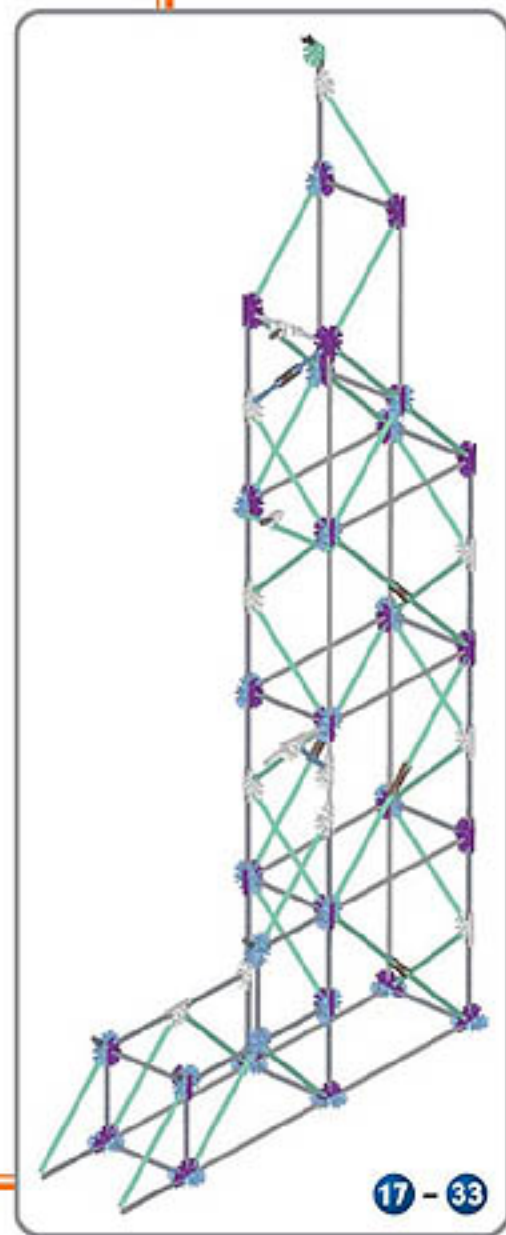
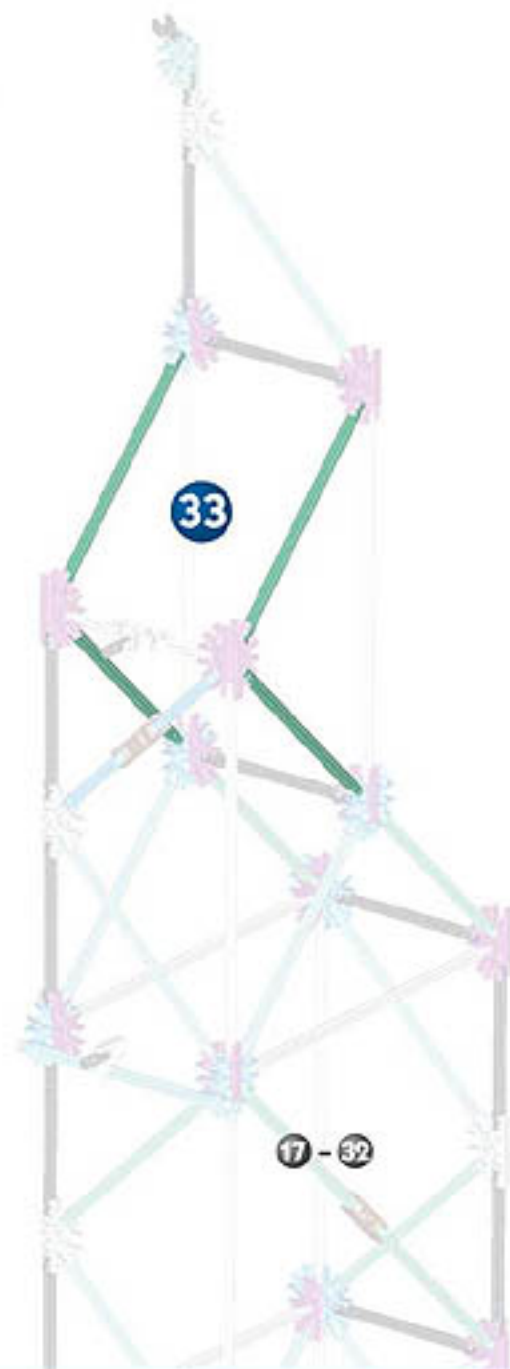
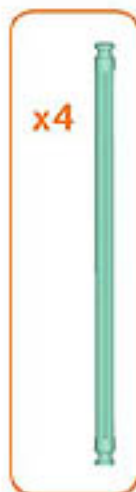
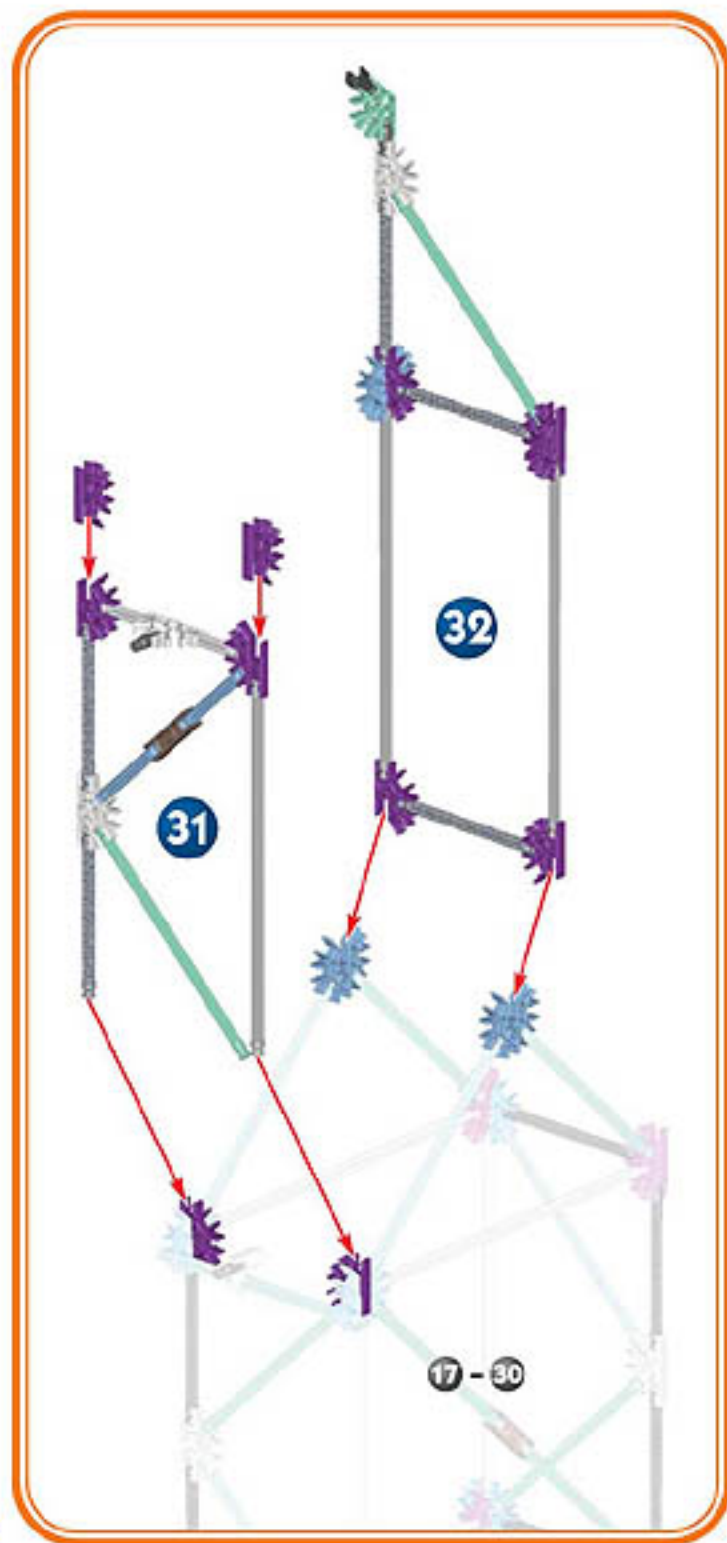



- x6 
- x8 
- x2 

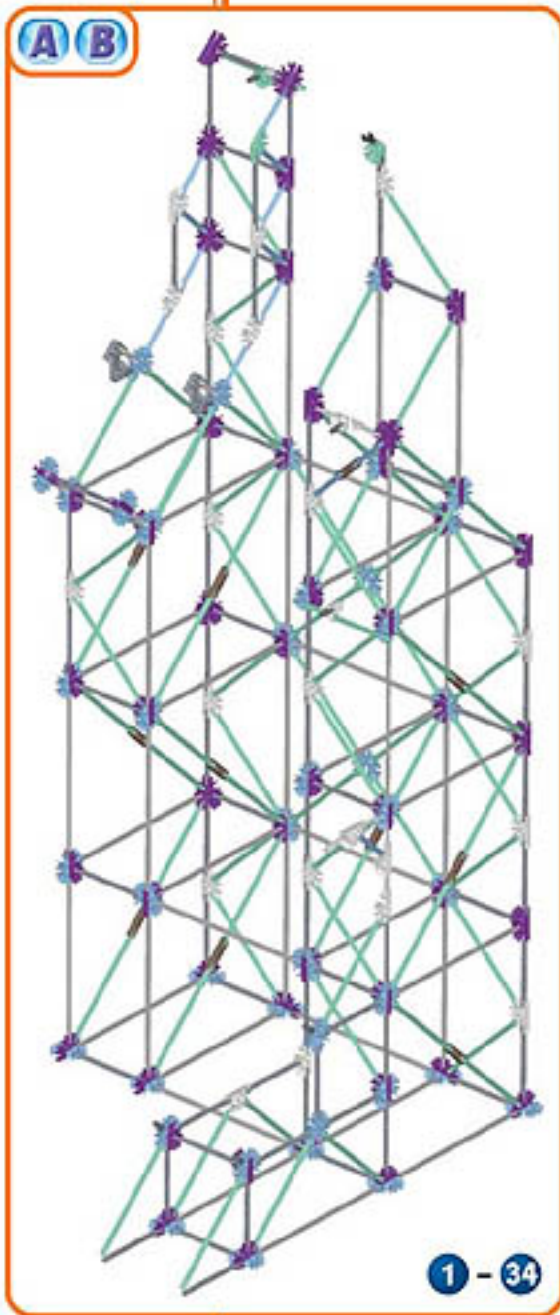
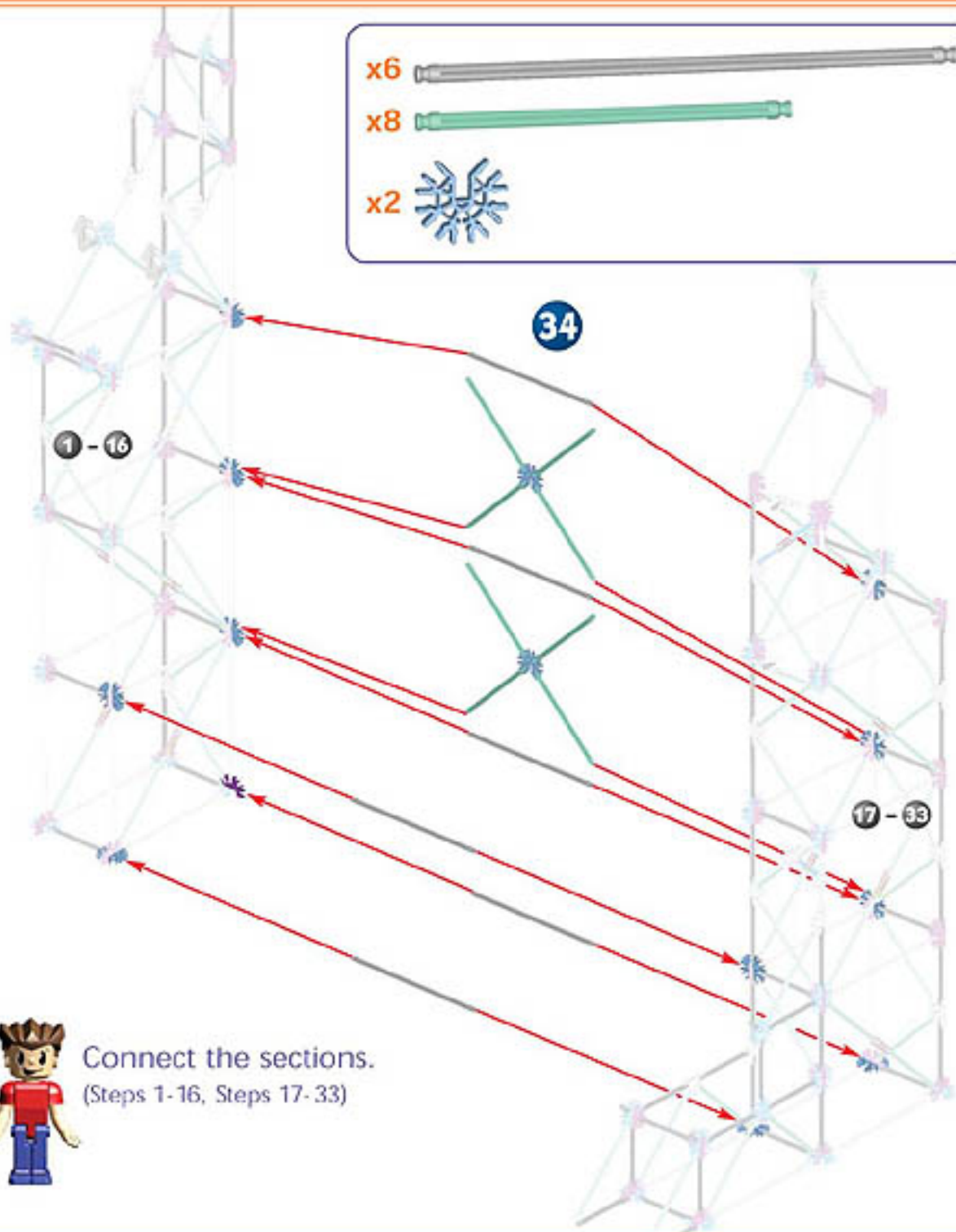

Connect the sections.
(Steps 1-16, Steps 17-33)

C

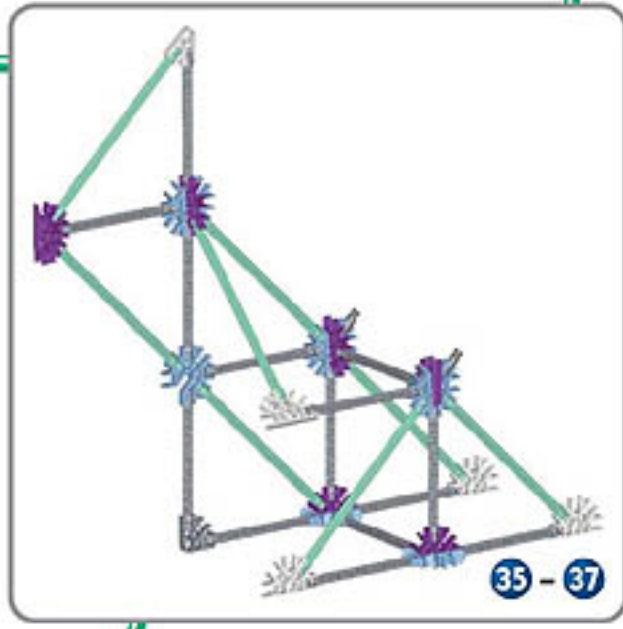
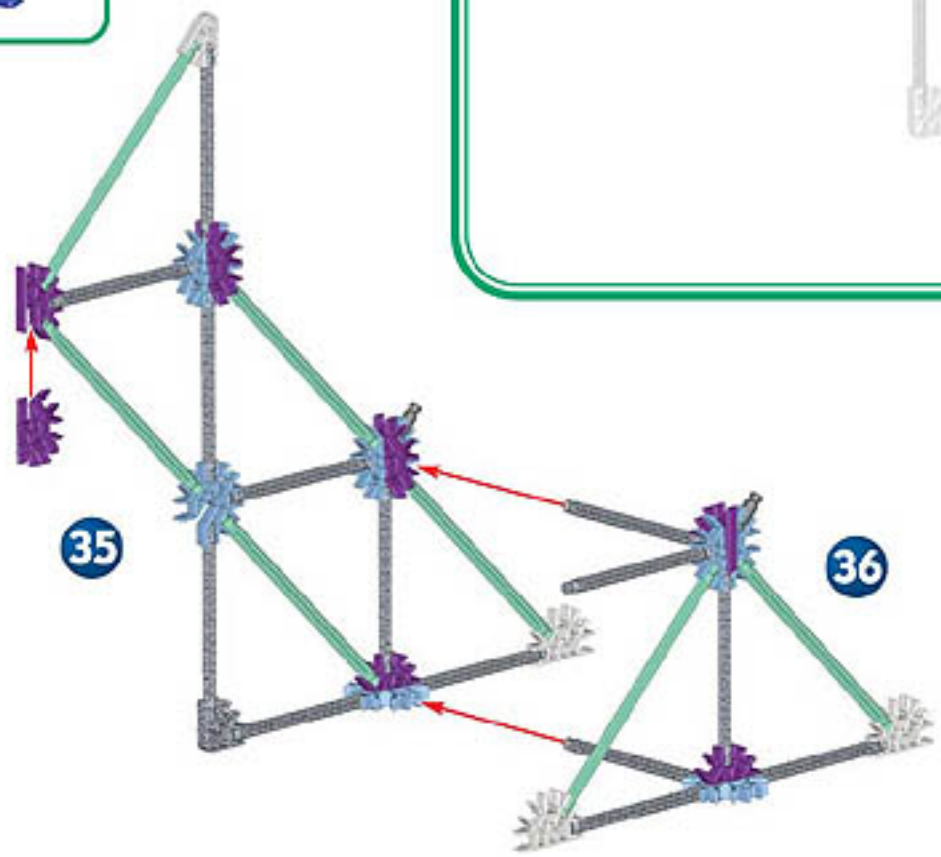
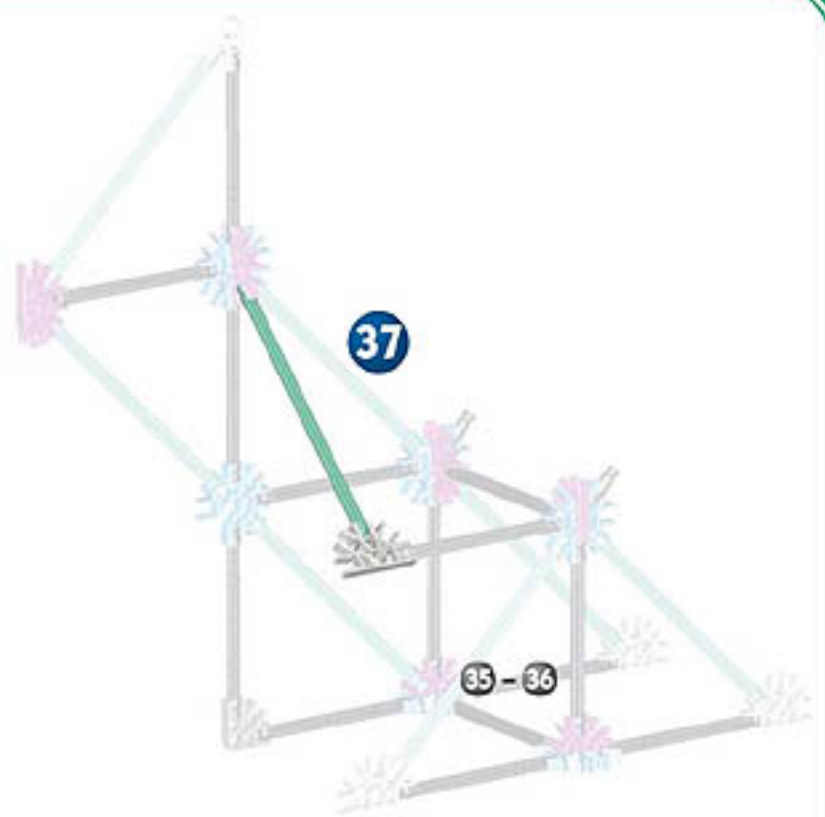
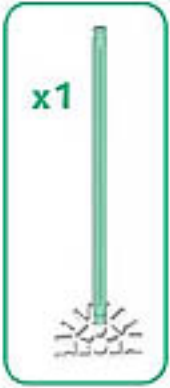
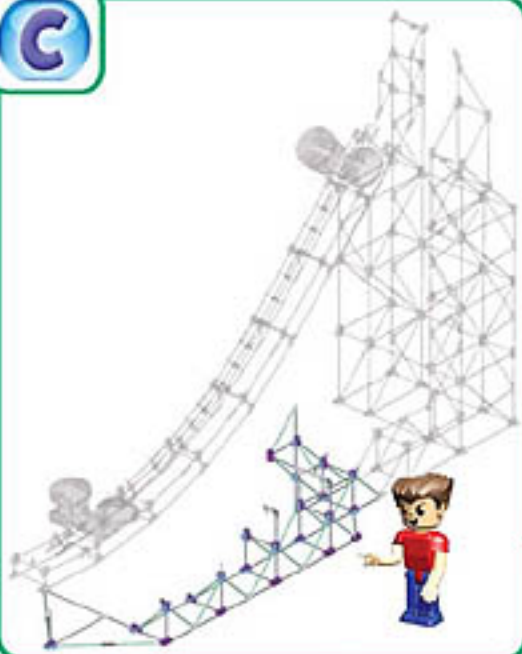

x5

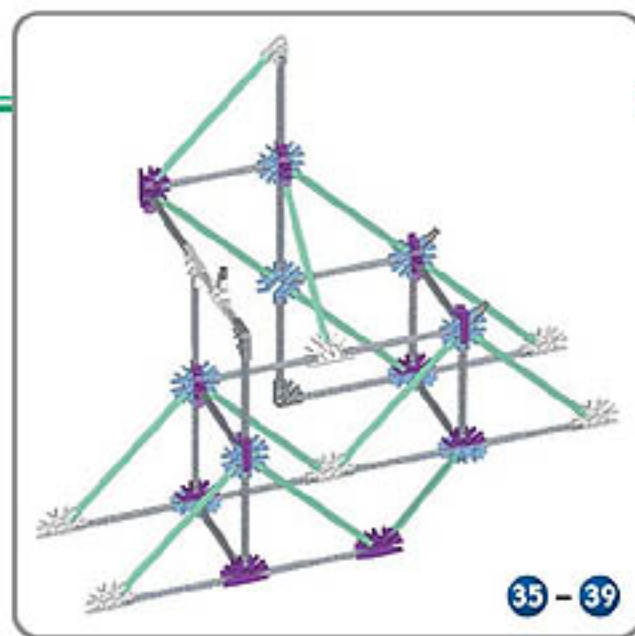
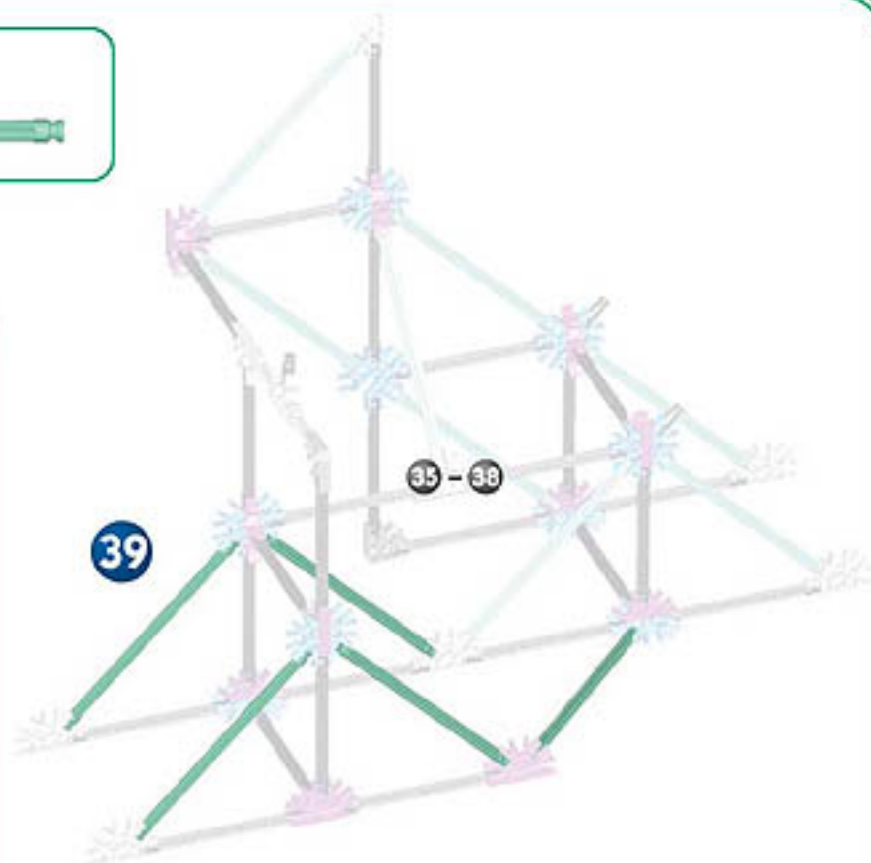
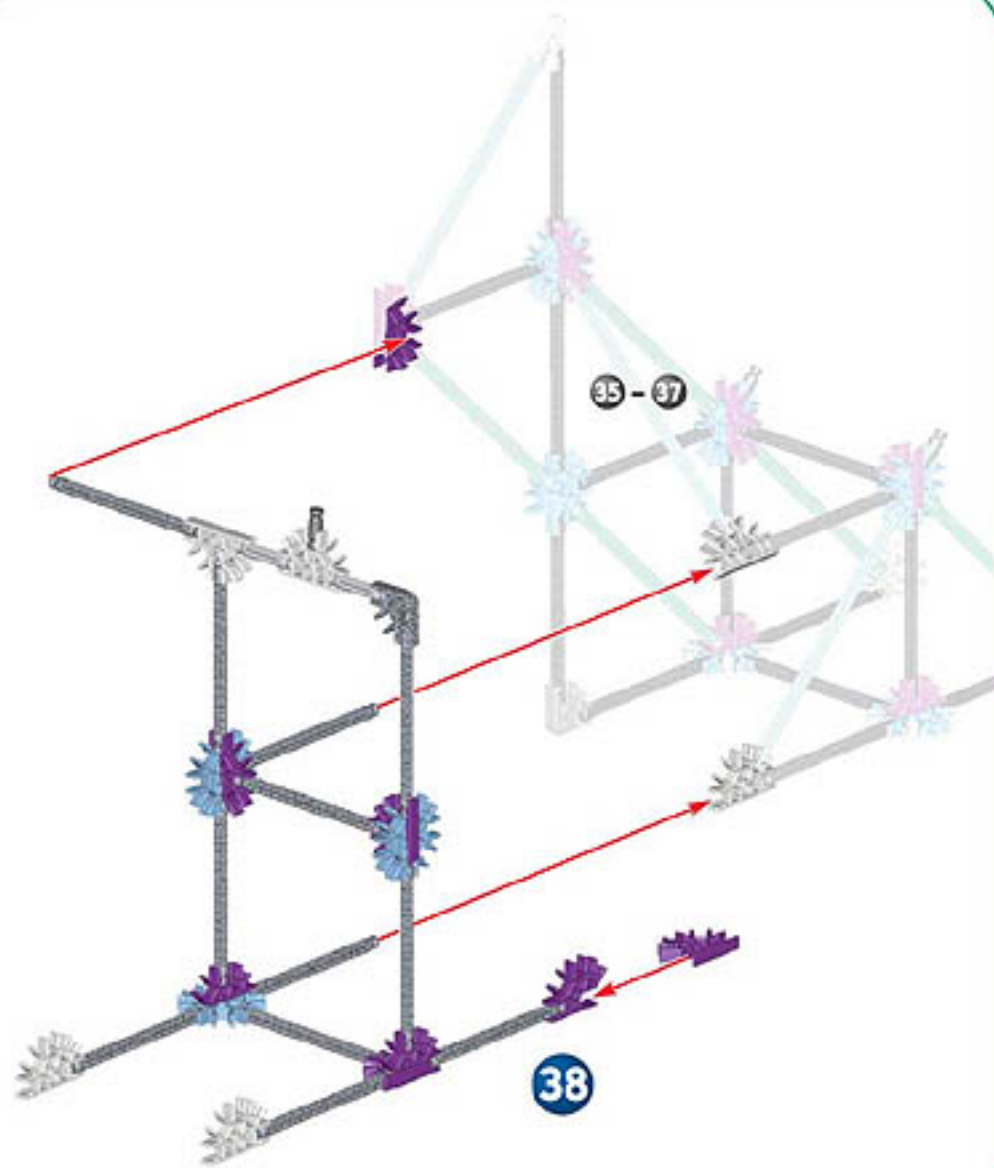

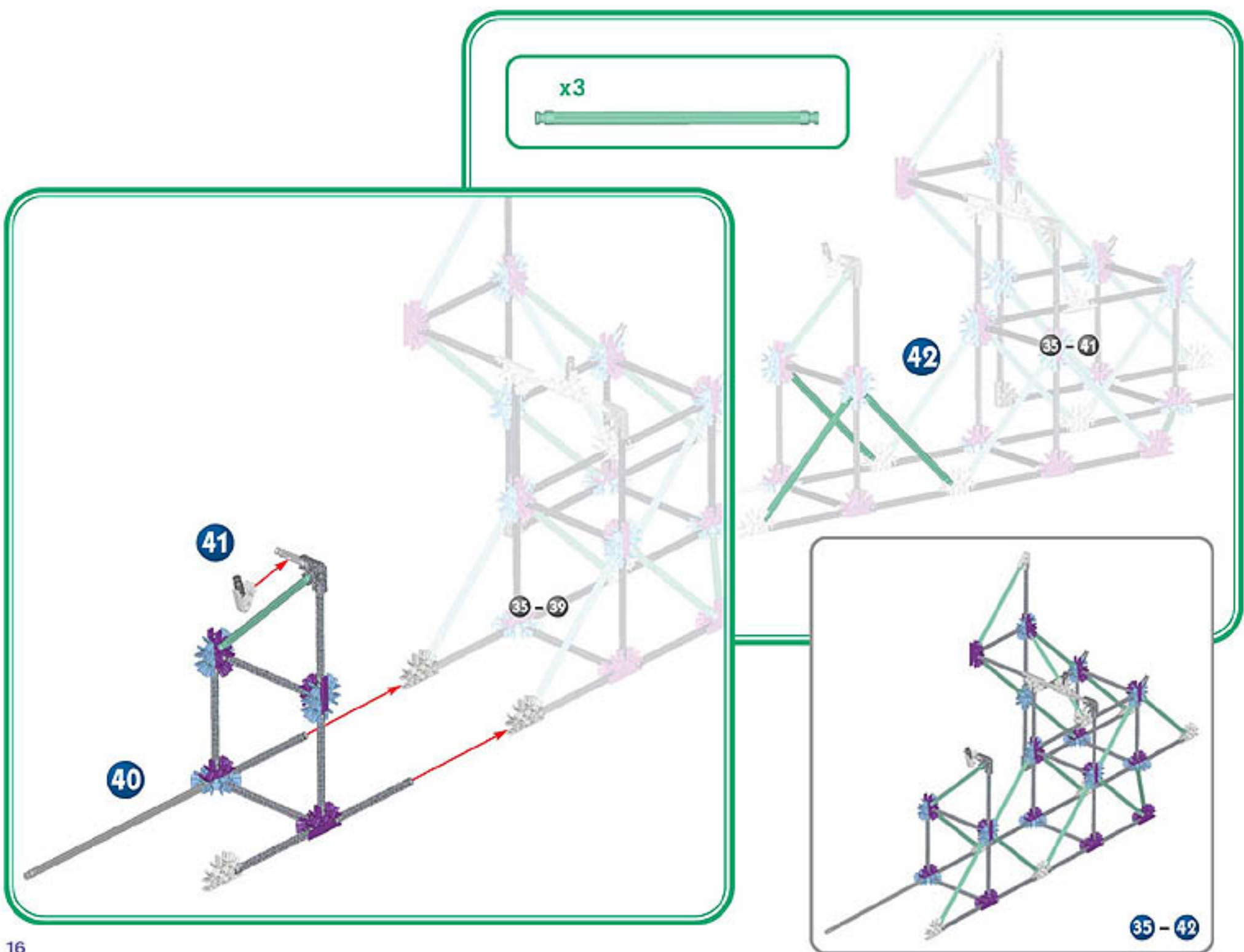

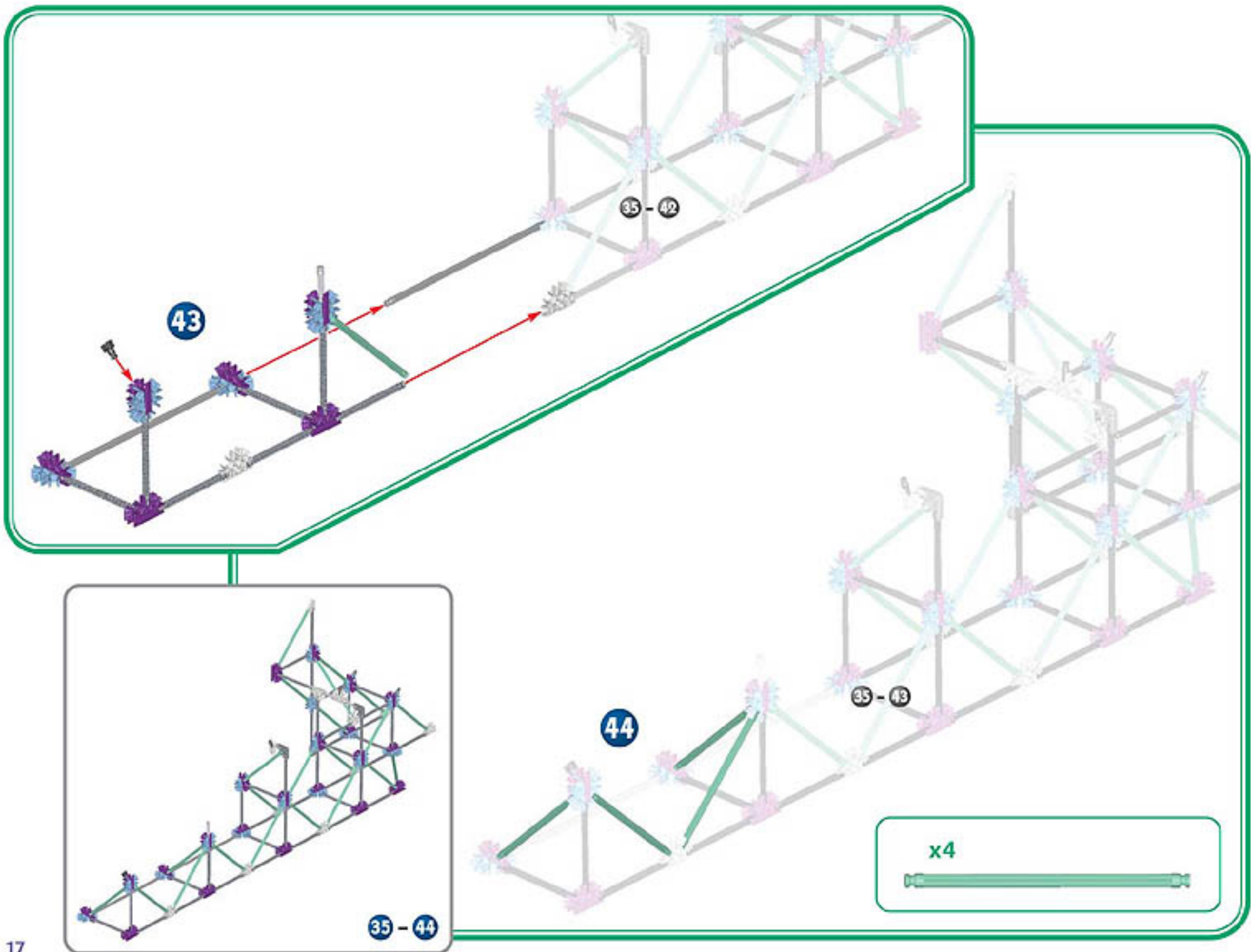

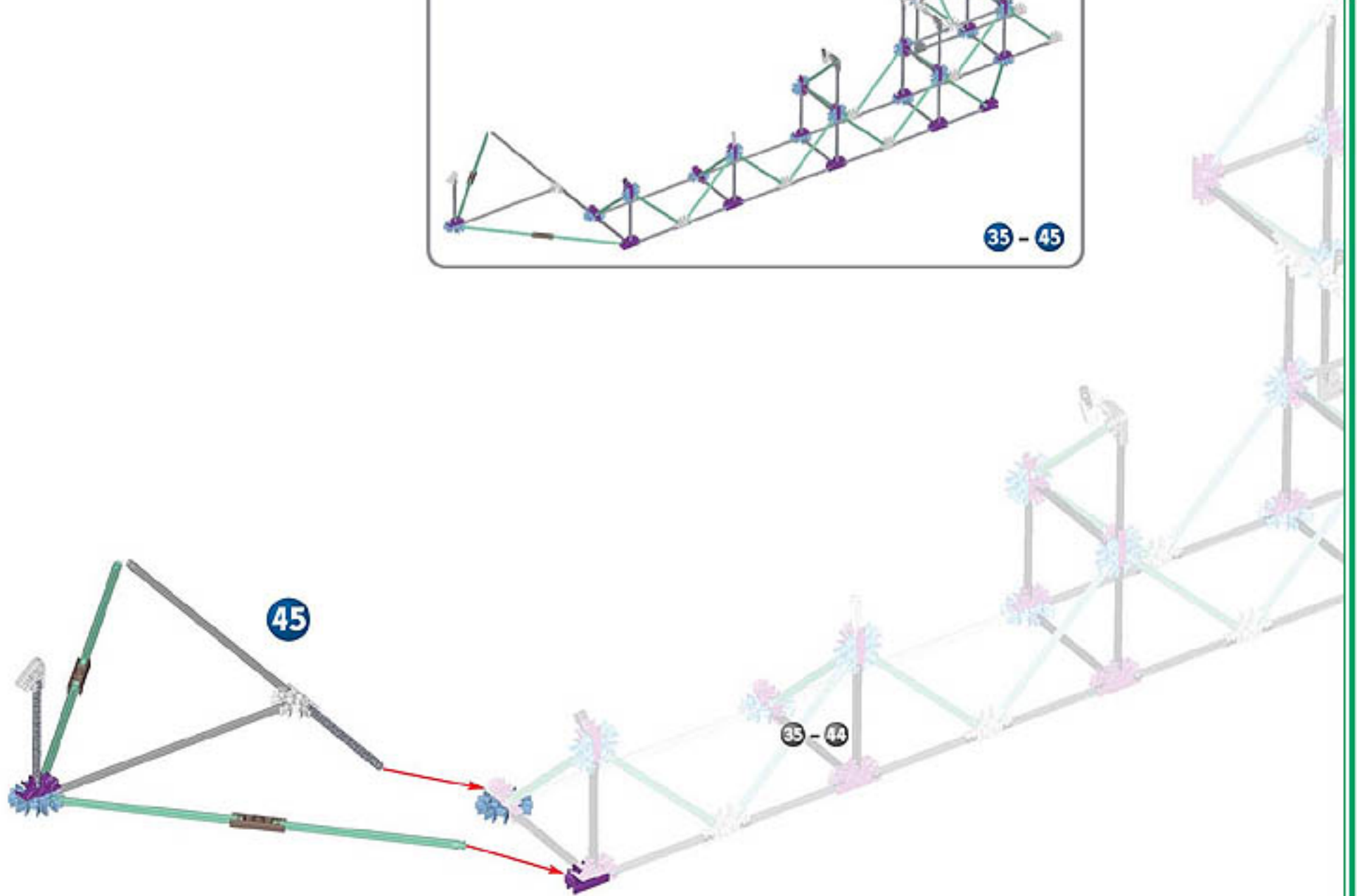
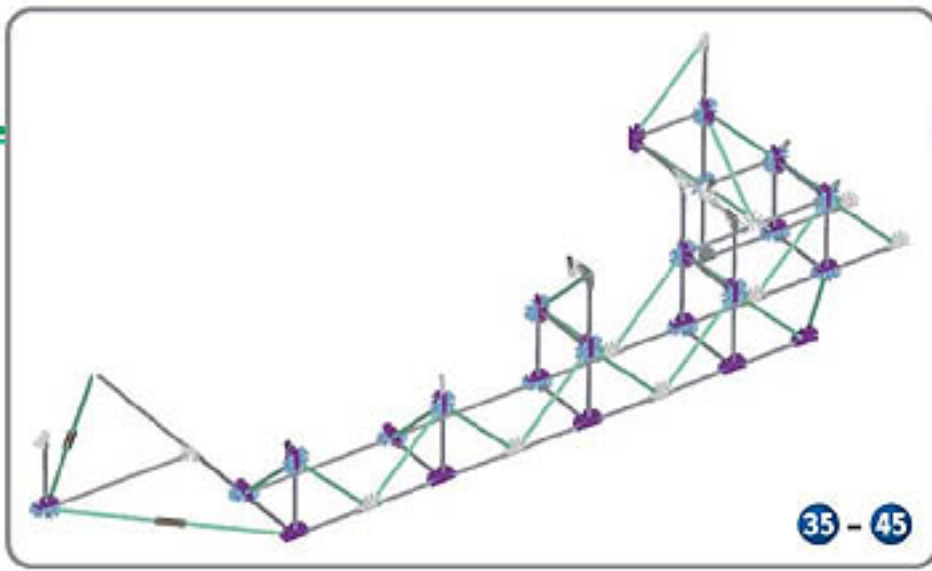

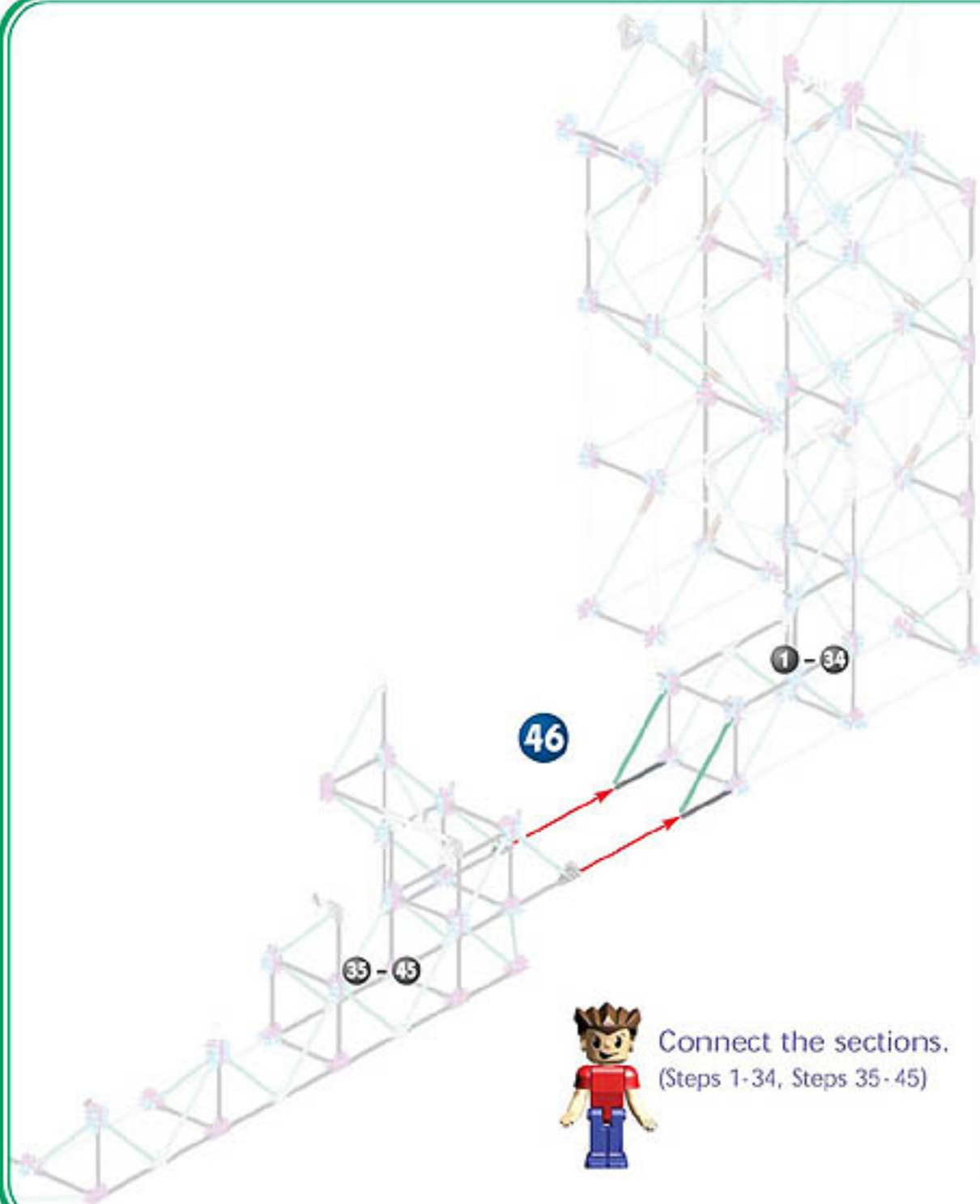

Connect the sections.
(Steps 1-34, Steps 35-45)

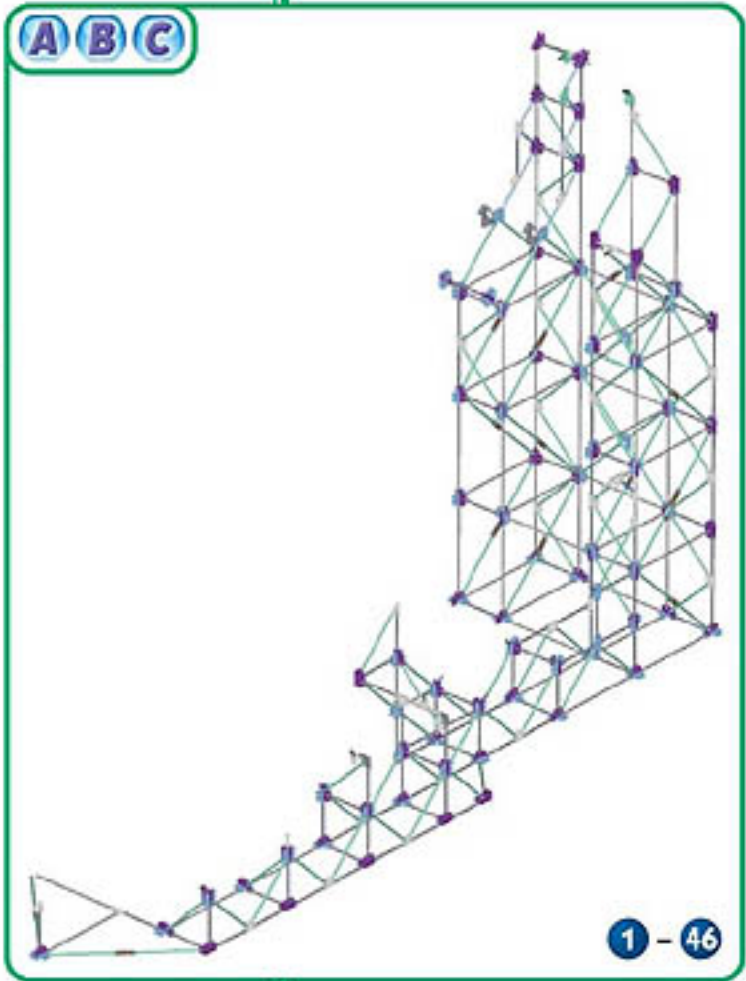

D

As you start to build the hill, the pieces will start to bend upwards.

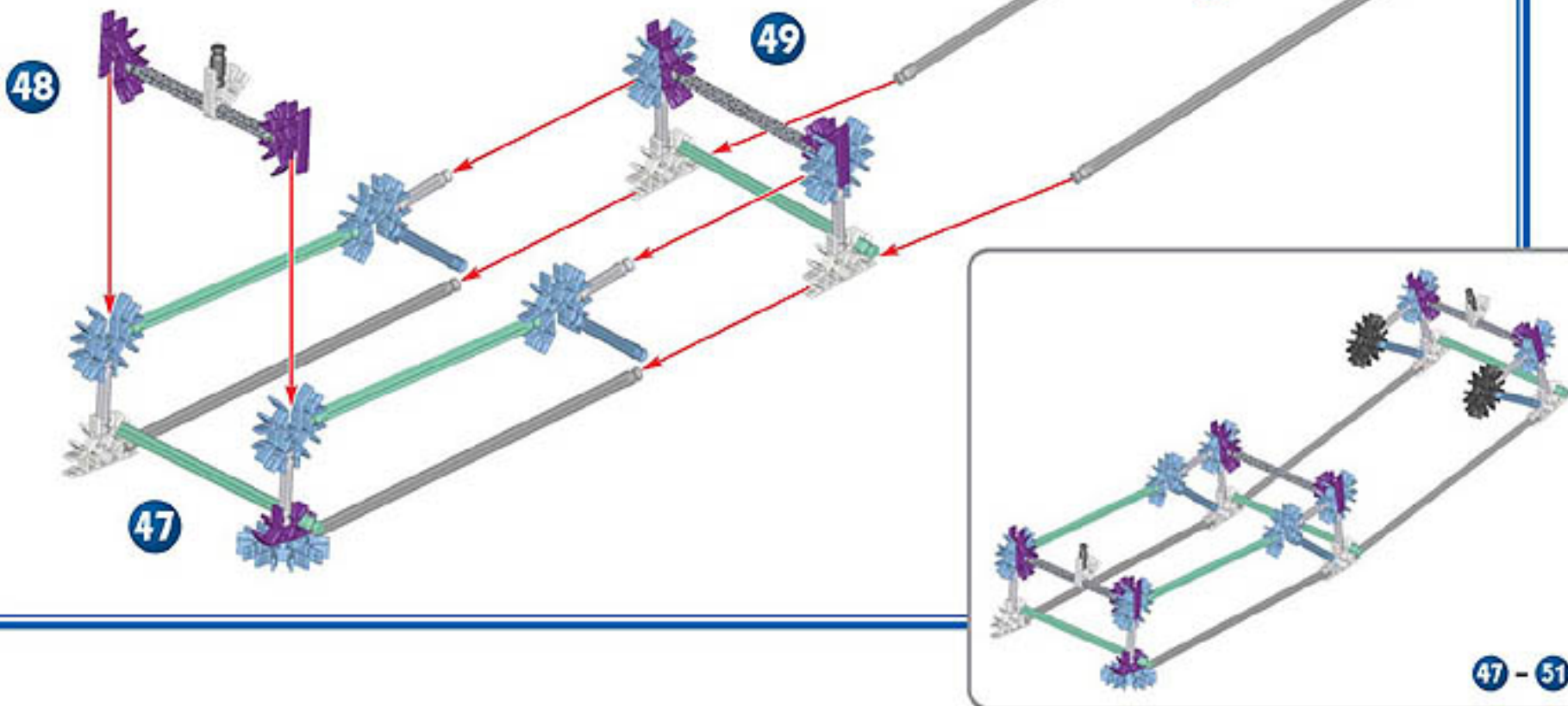

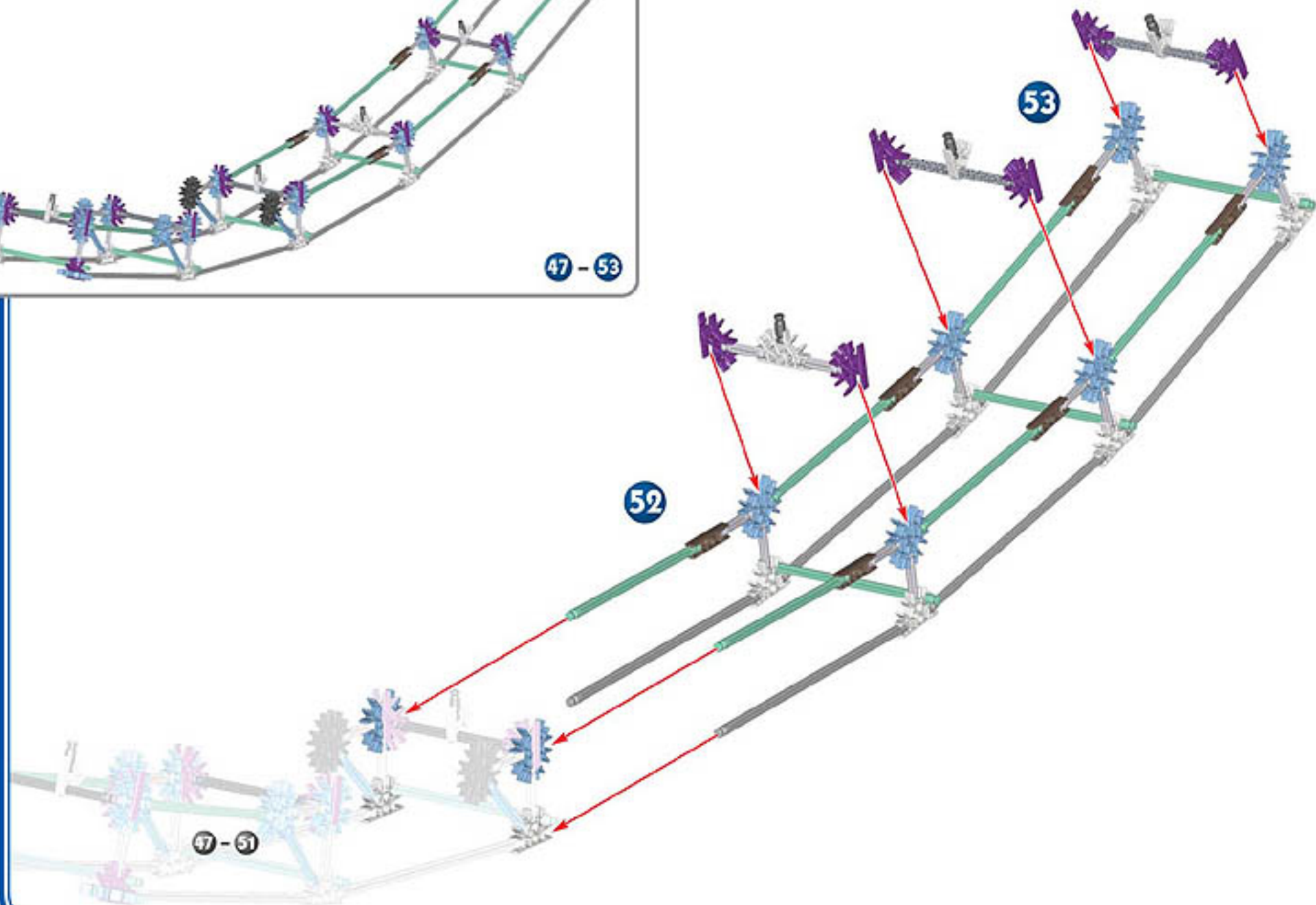
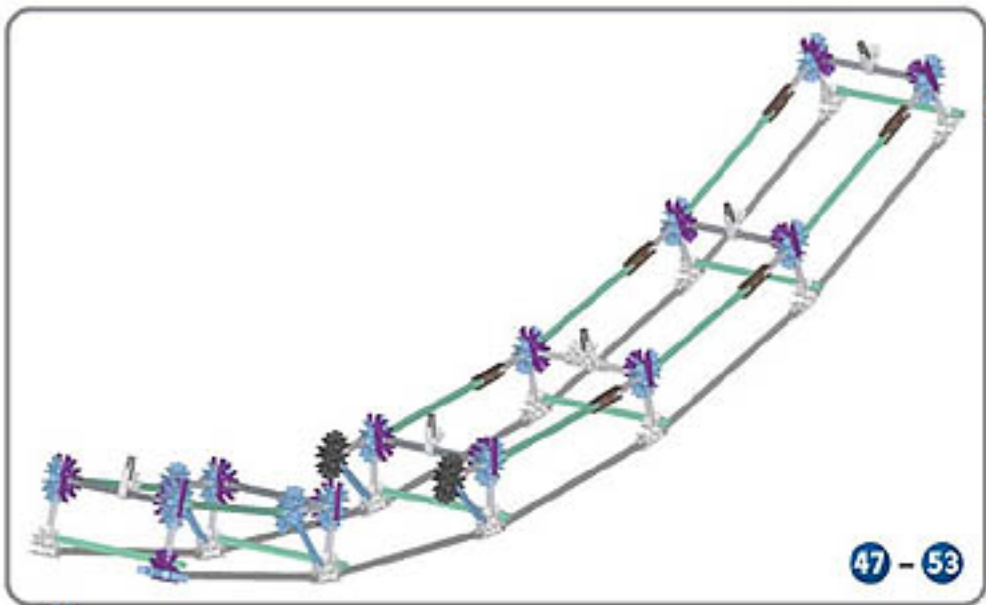

Number of
Track Connectors
needed



54

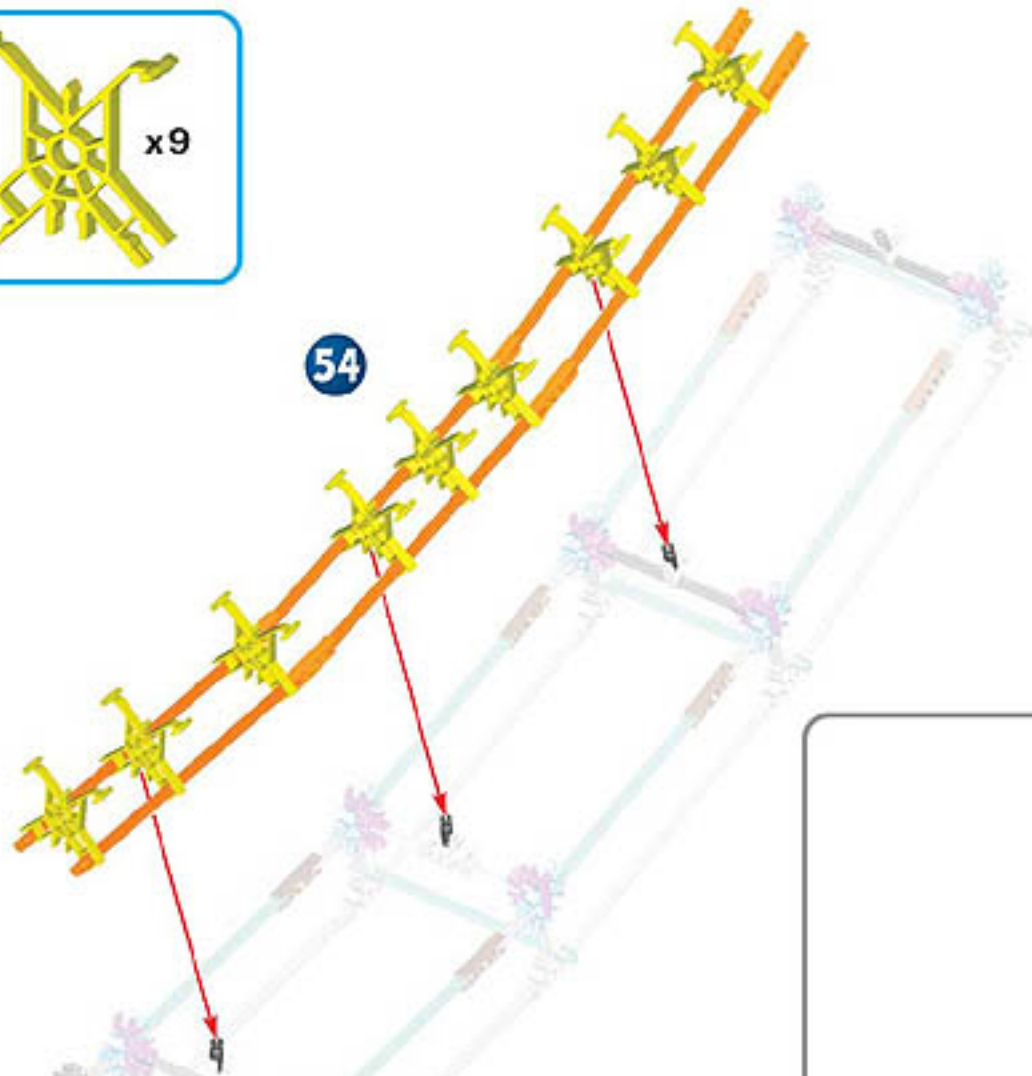

47 - 53

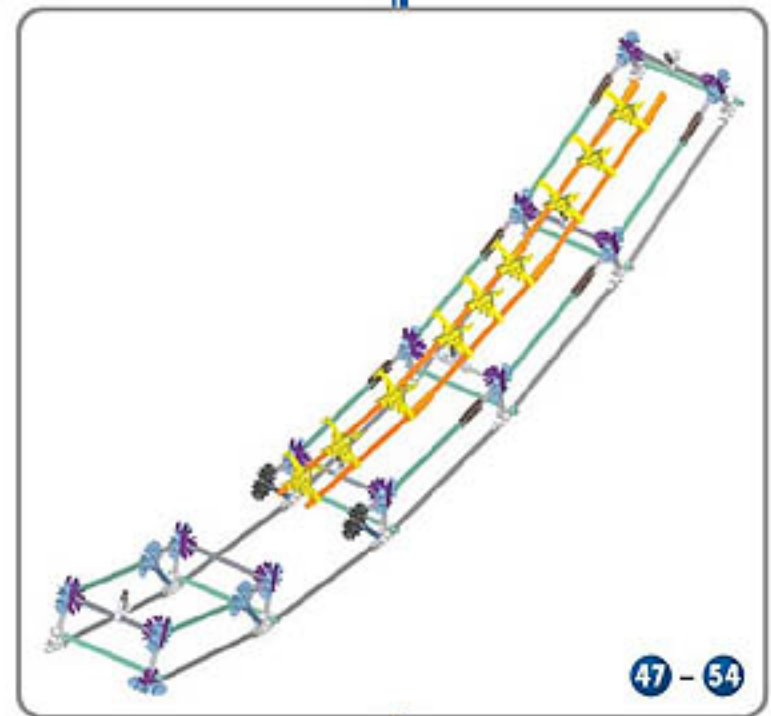

47 - 54

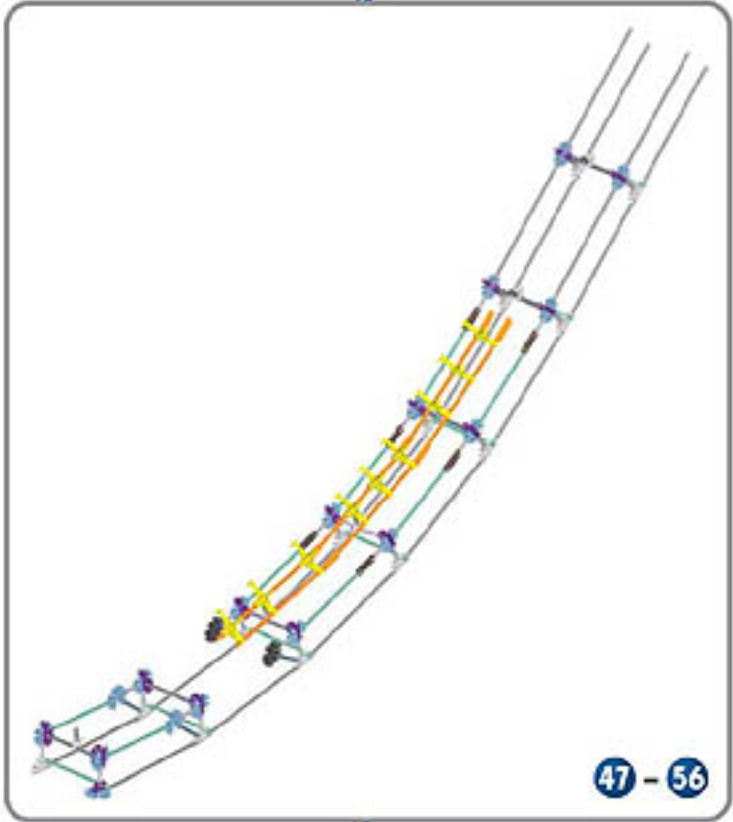
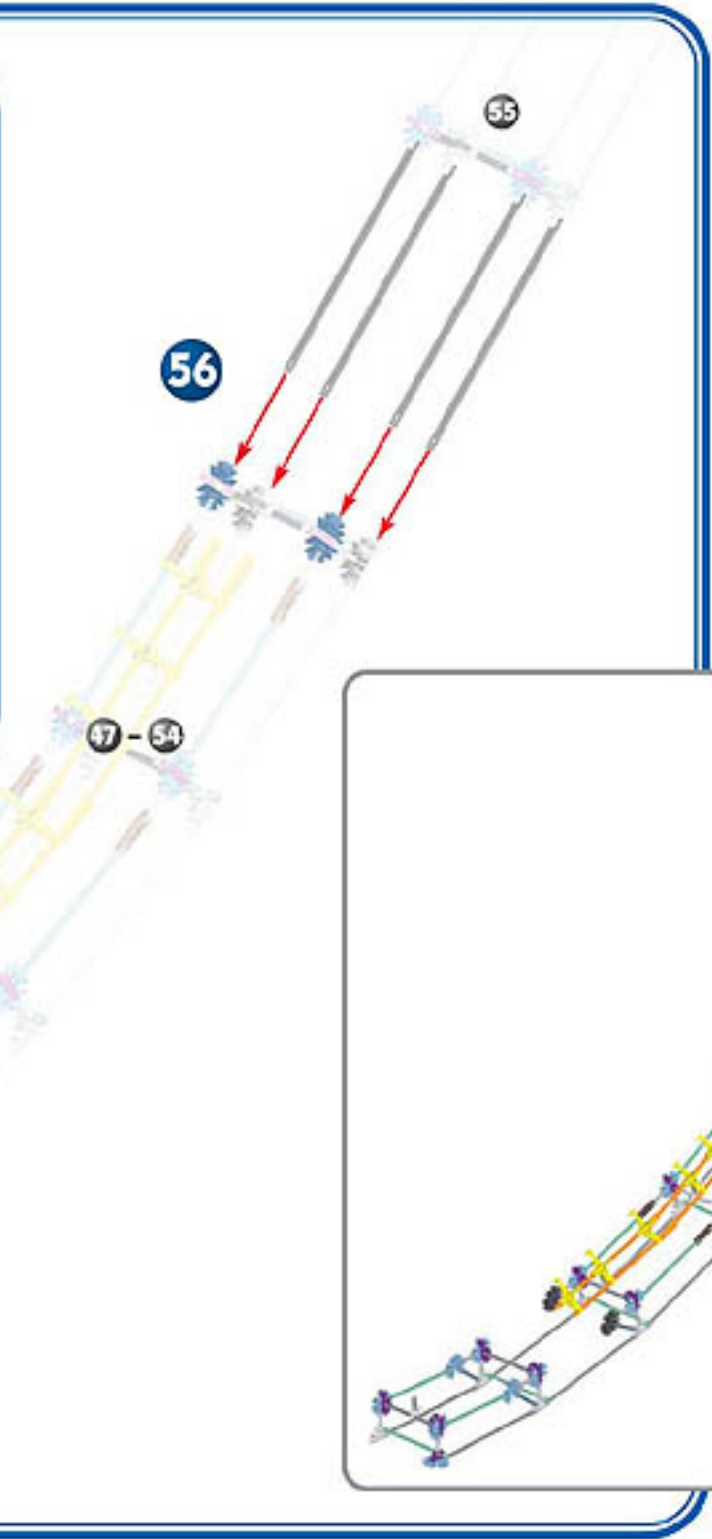
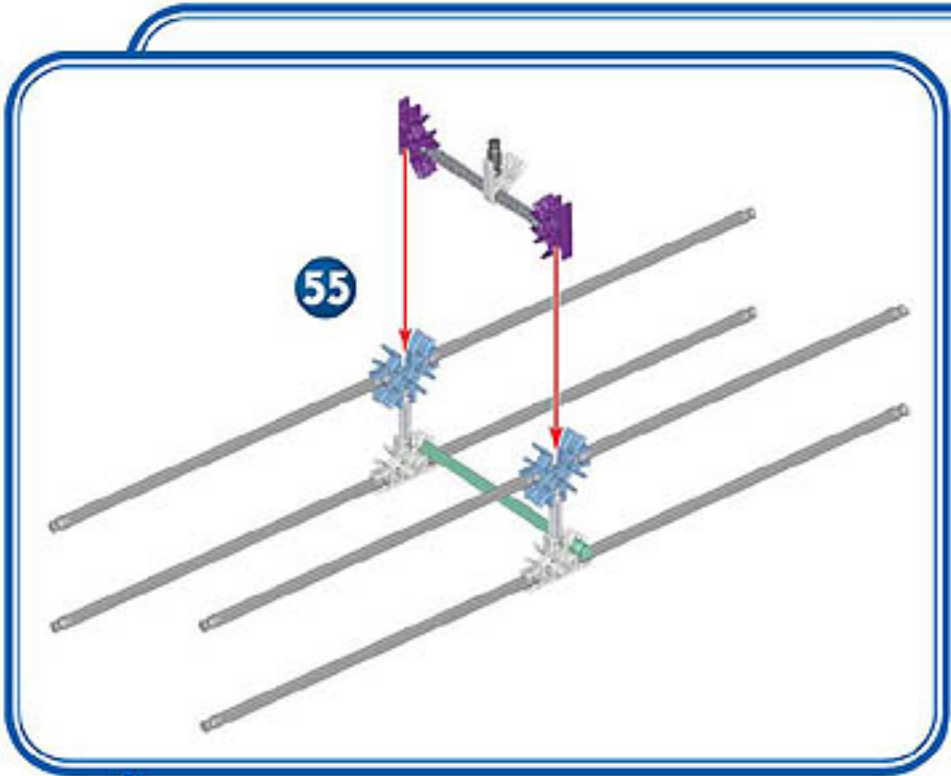



57

47 - 56

47 - 57

A B C D

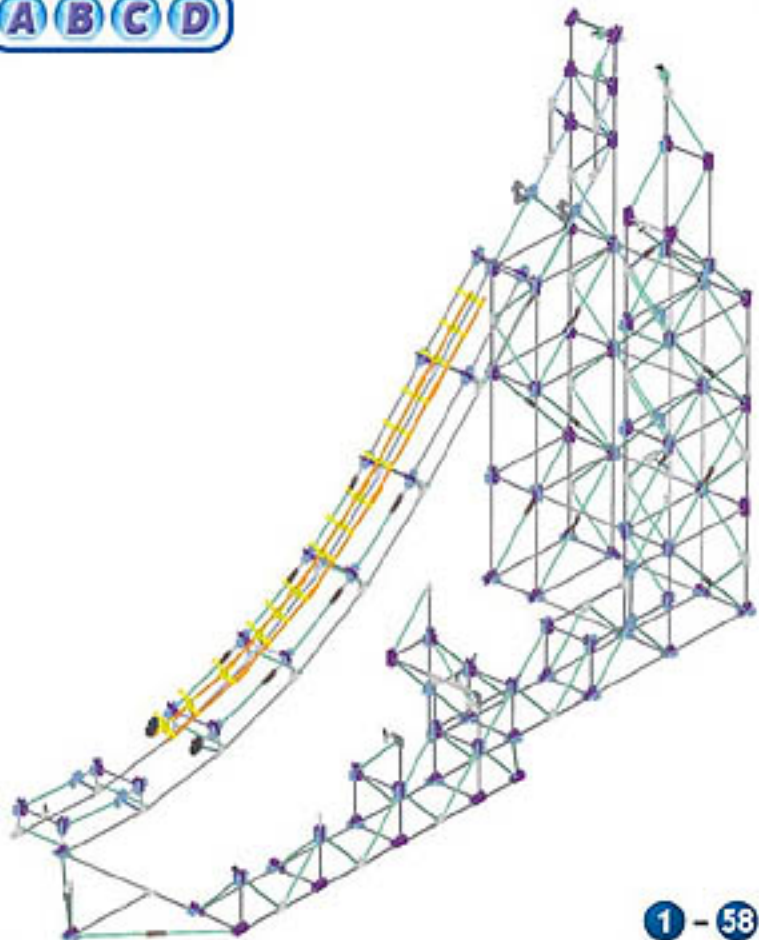

Connect the sections.
(Steps 1-46, Steps 47-57)

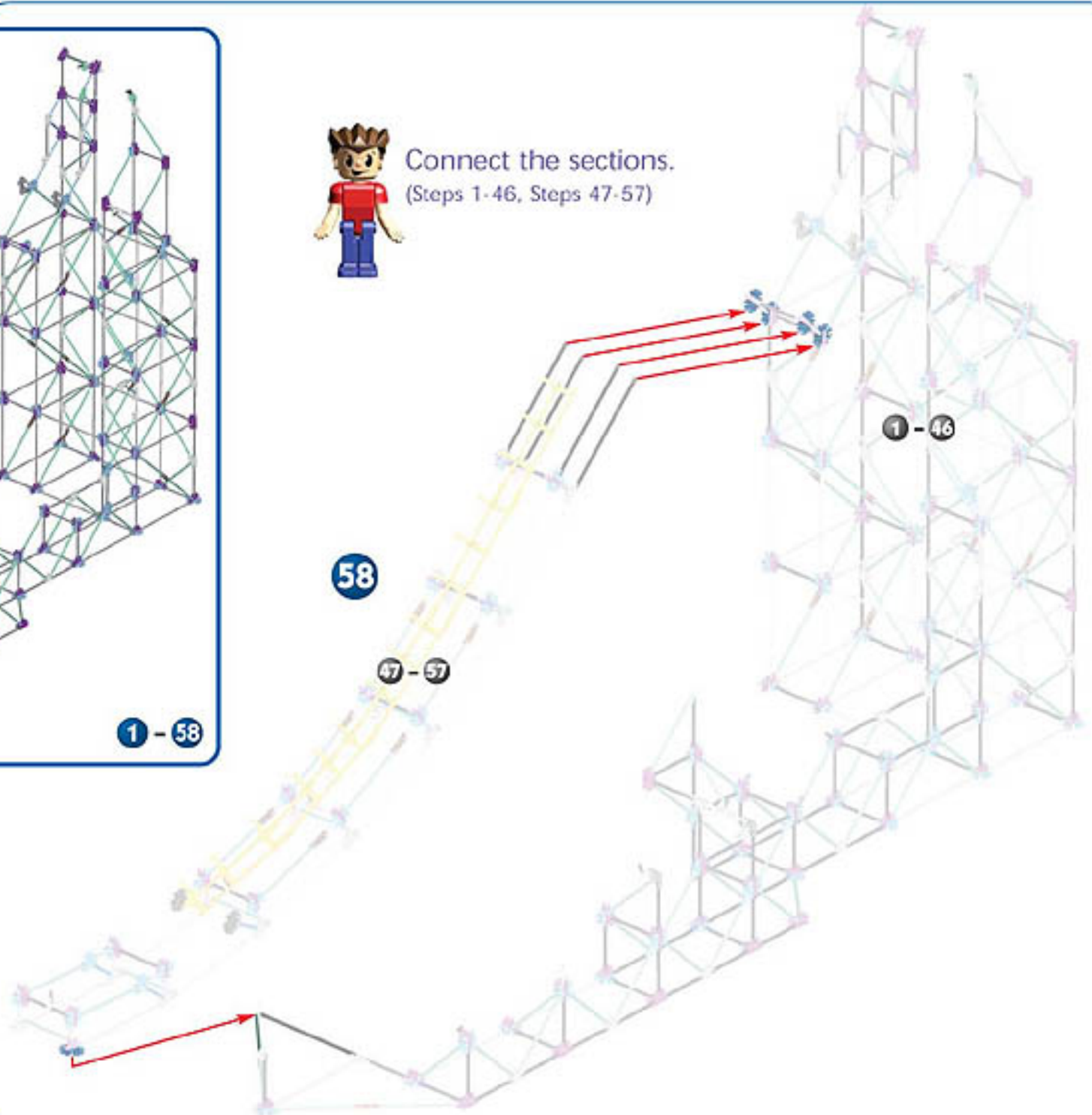

E

Install all batteries in the Turbo Booster before building.

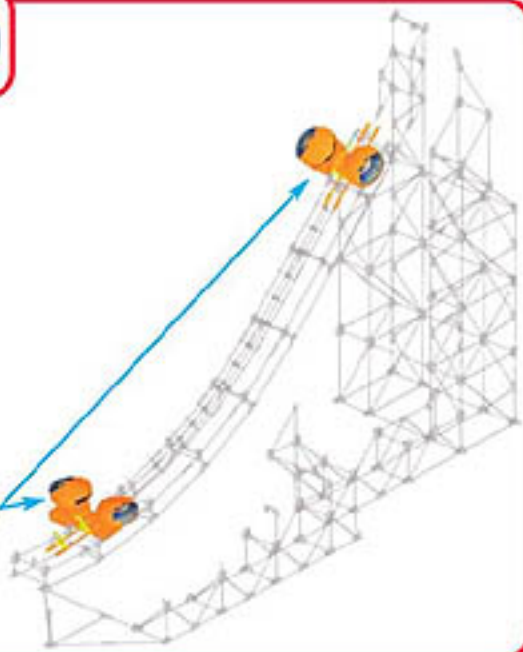

Arrow on Turbo Booster must point forward.

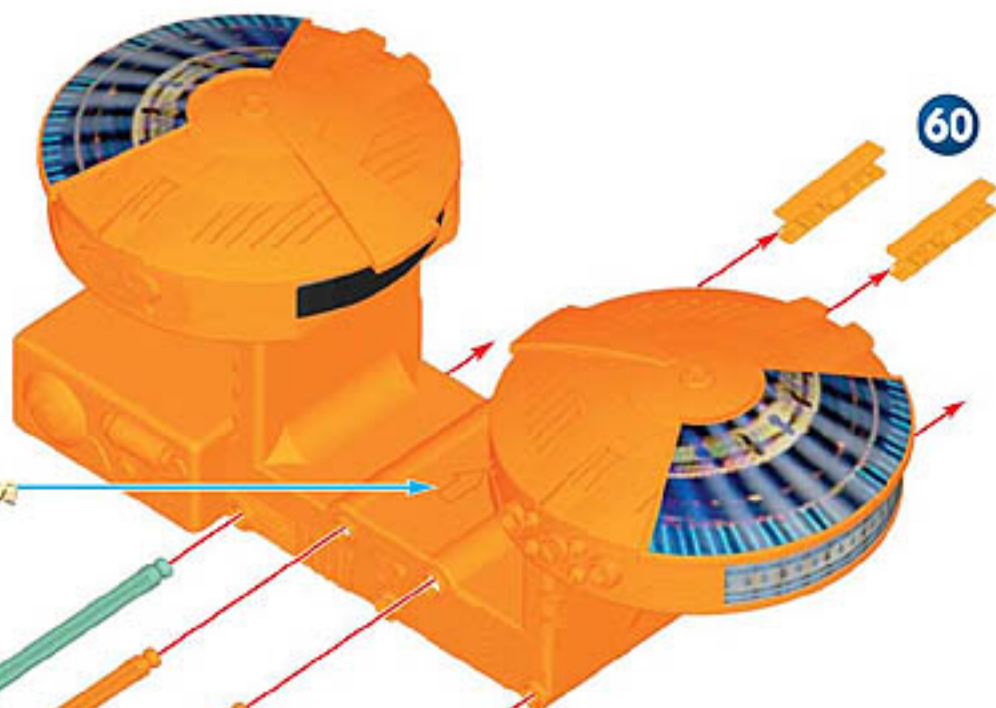
**60****59****x2**

Push the Track Connector against the Turbo Booster.

**59 - 60**



Install all batteries in the second Turbo Booster before building.

Arrow on Turbo Booster must point forward.



61

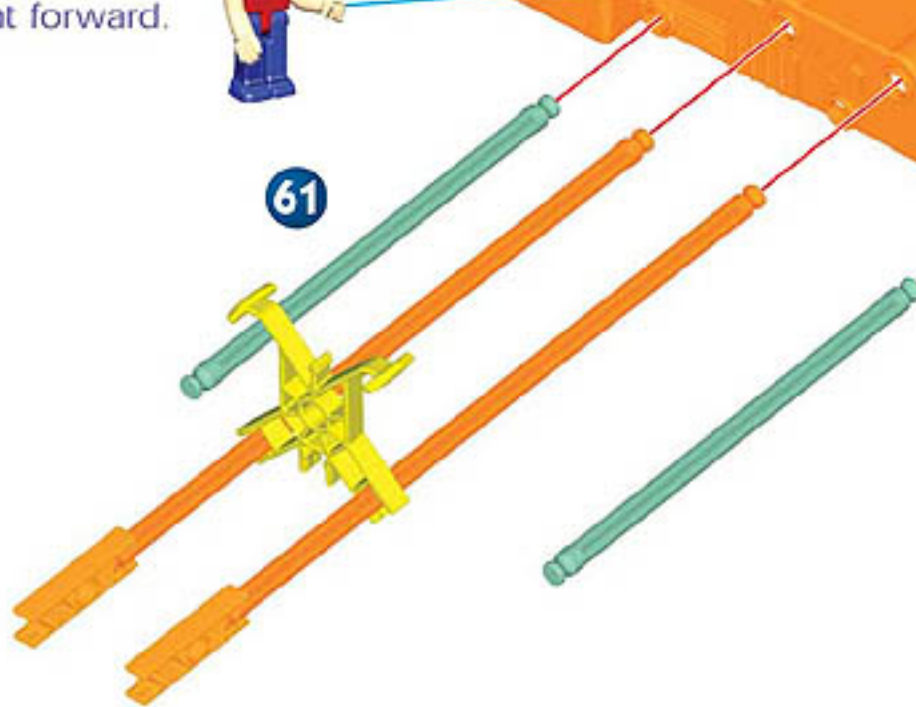

62

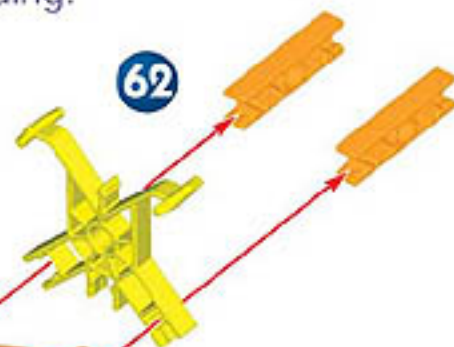

Push the 2 Track Connectors against the Turbo Booster.



61 - 62

A B C D E

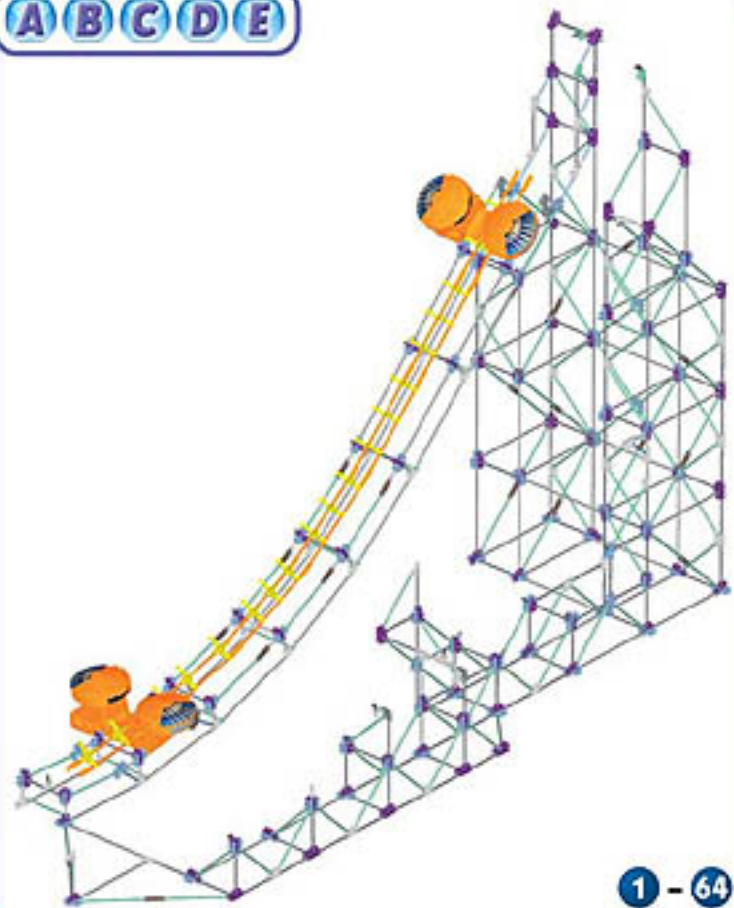

1 - 64



Connect the sections.
(Steps 1-58, Steps 59-62)

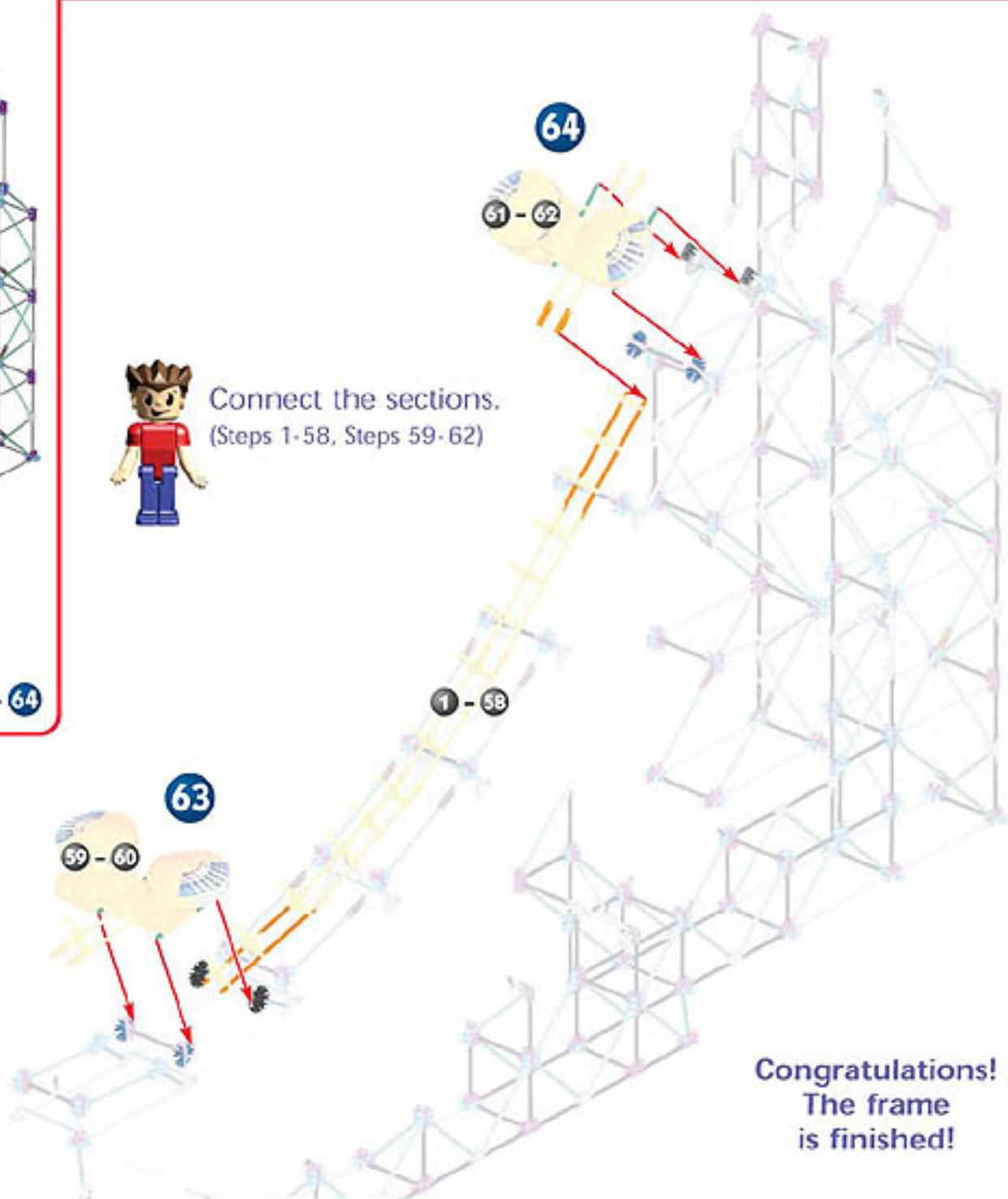

64

61 - 62

1 - 58

63

59 - 60

Congratulations!
The frame
is finished!

Now it's time to put on the Track Connectors! Pay close attention to number and placement. Start at the top of the hill.



65

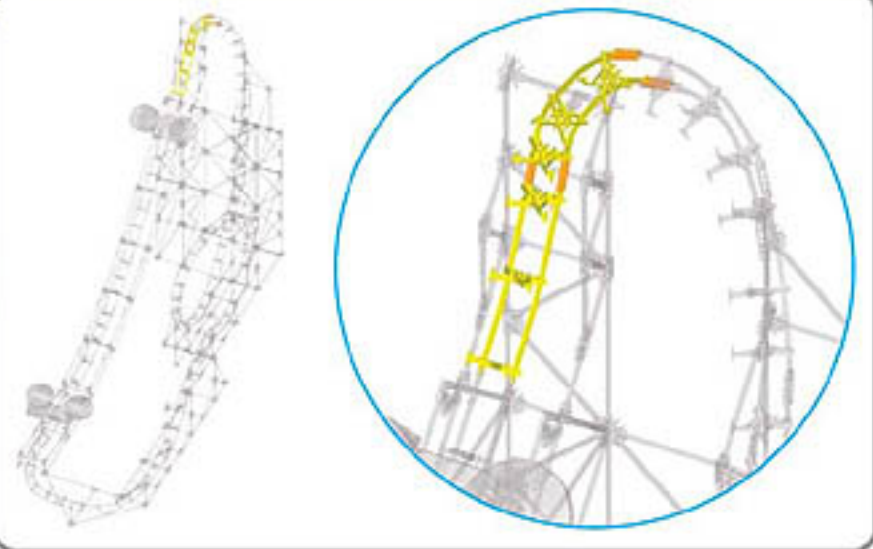
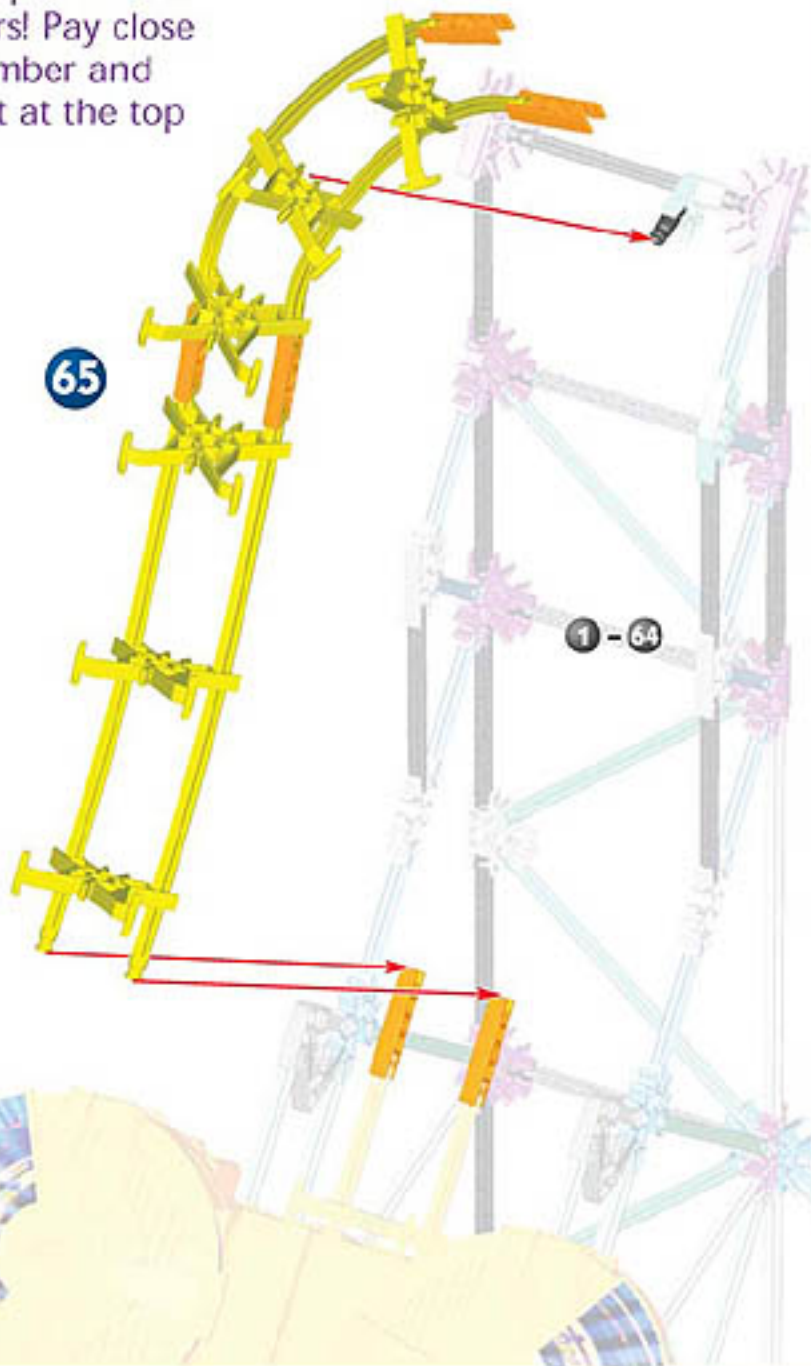

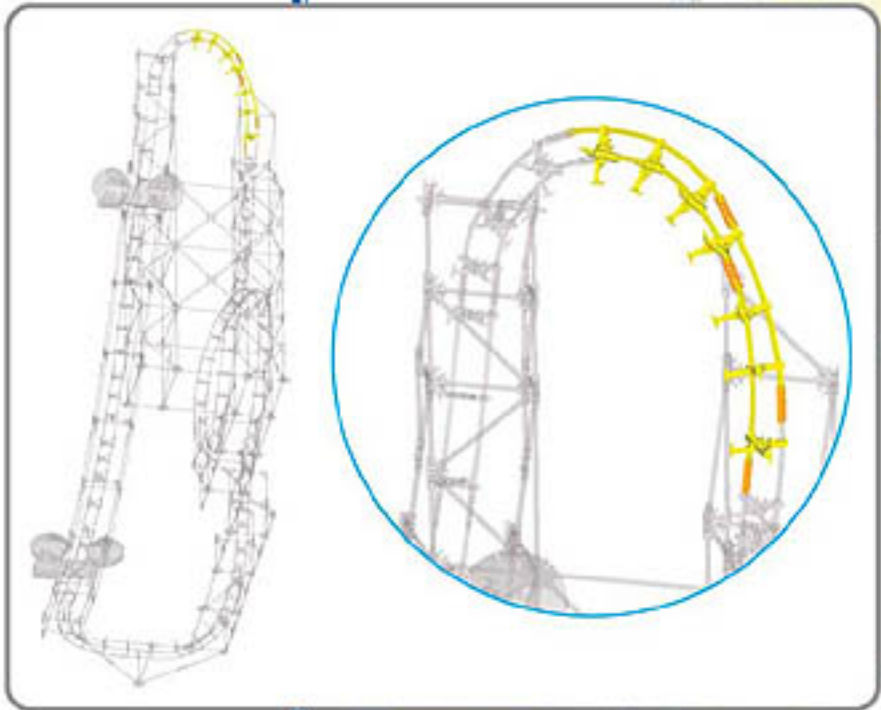

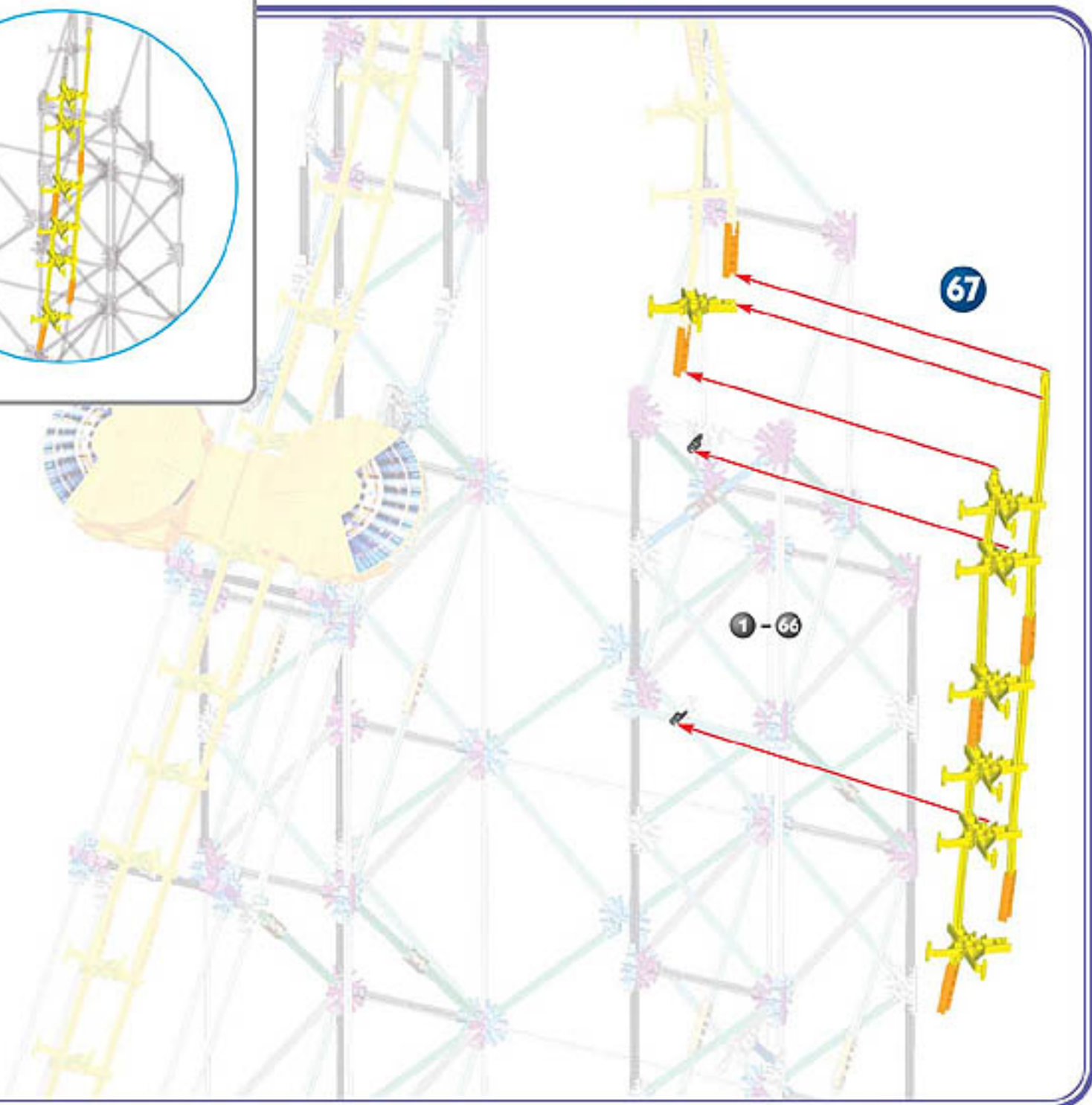
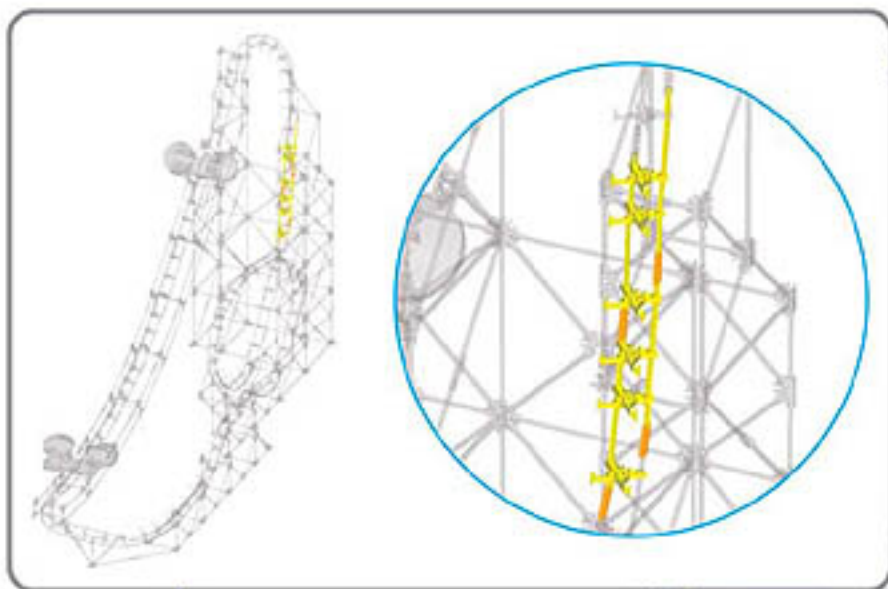

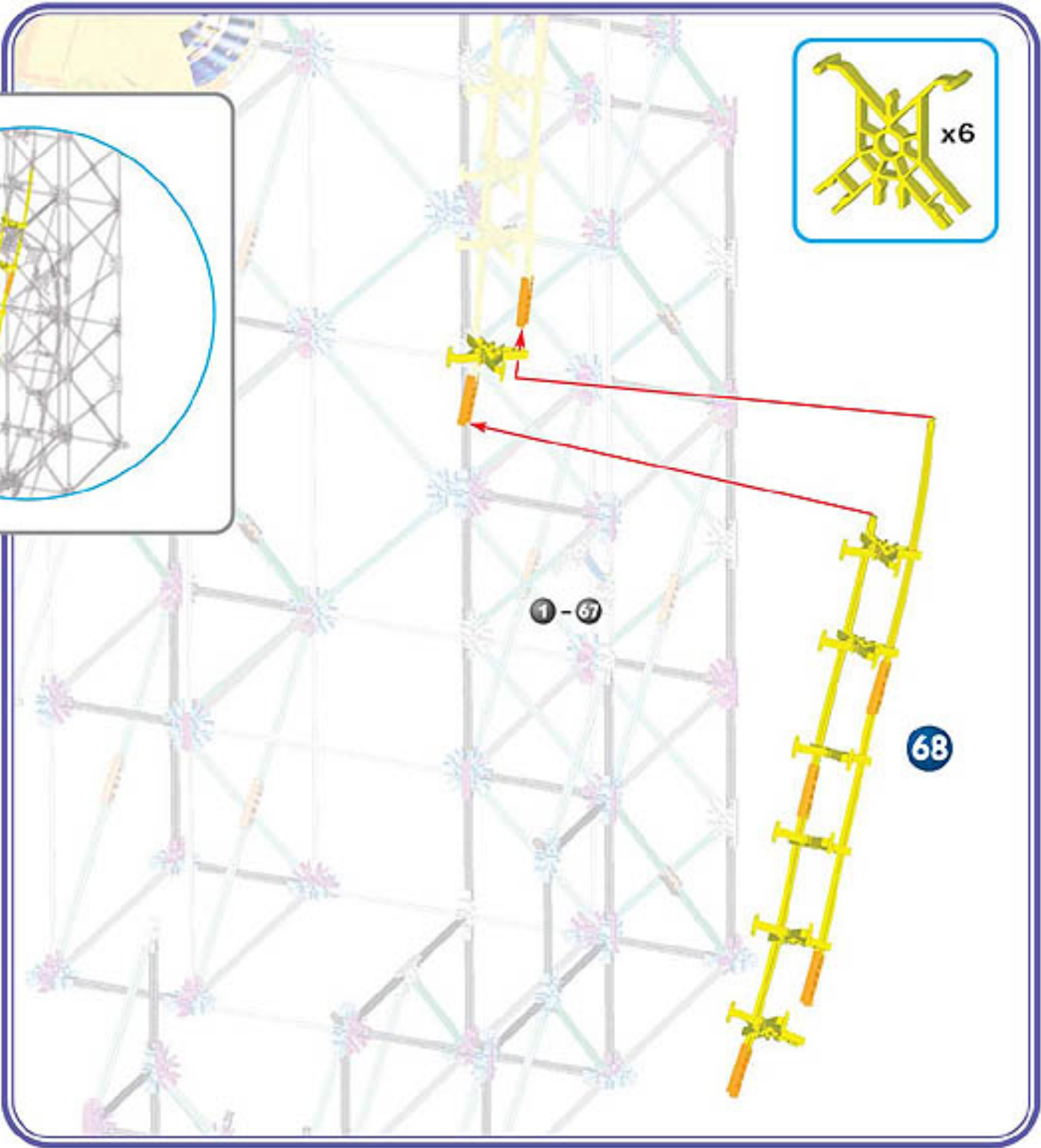
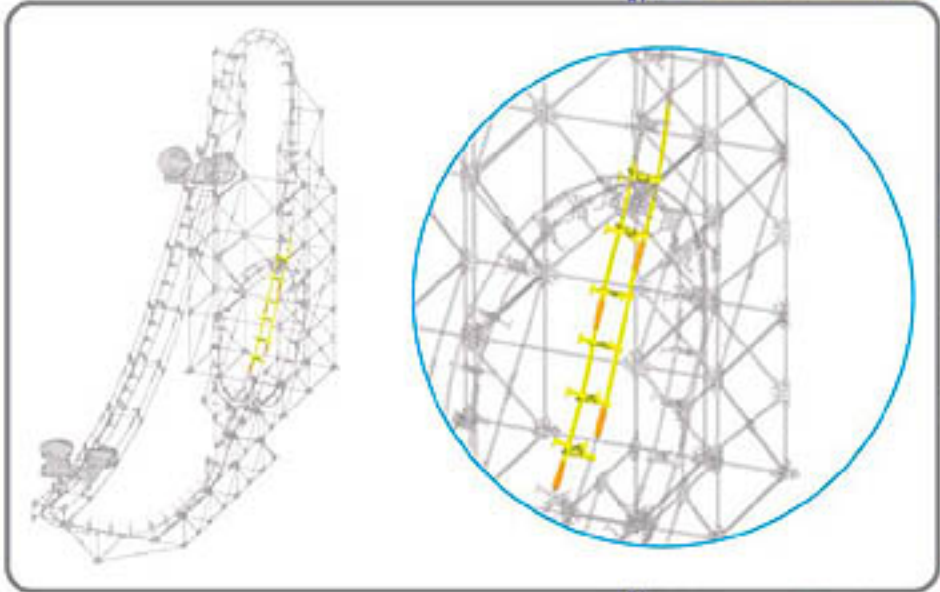

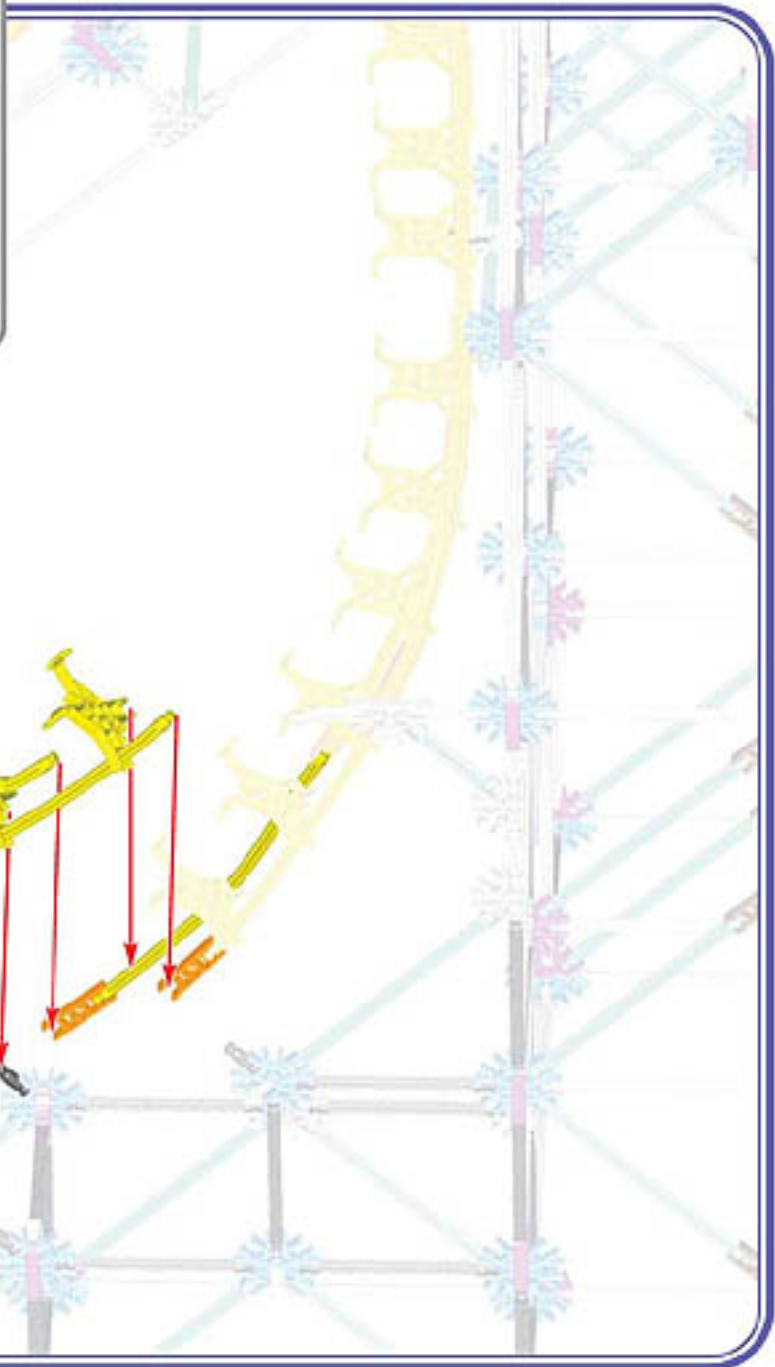
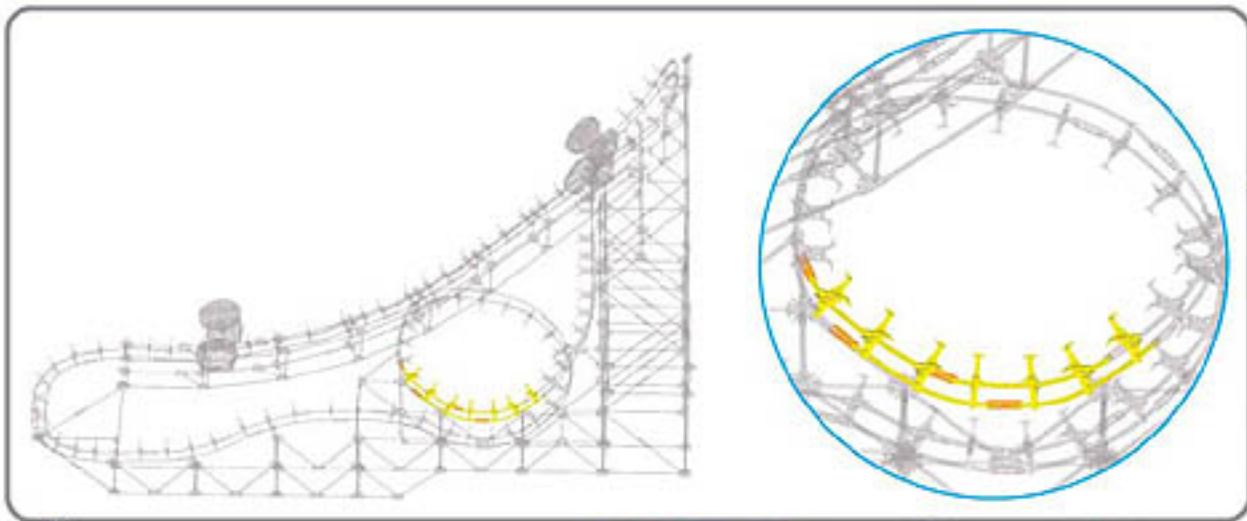

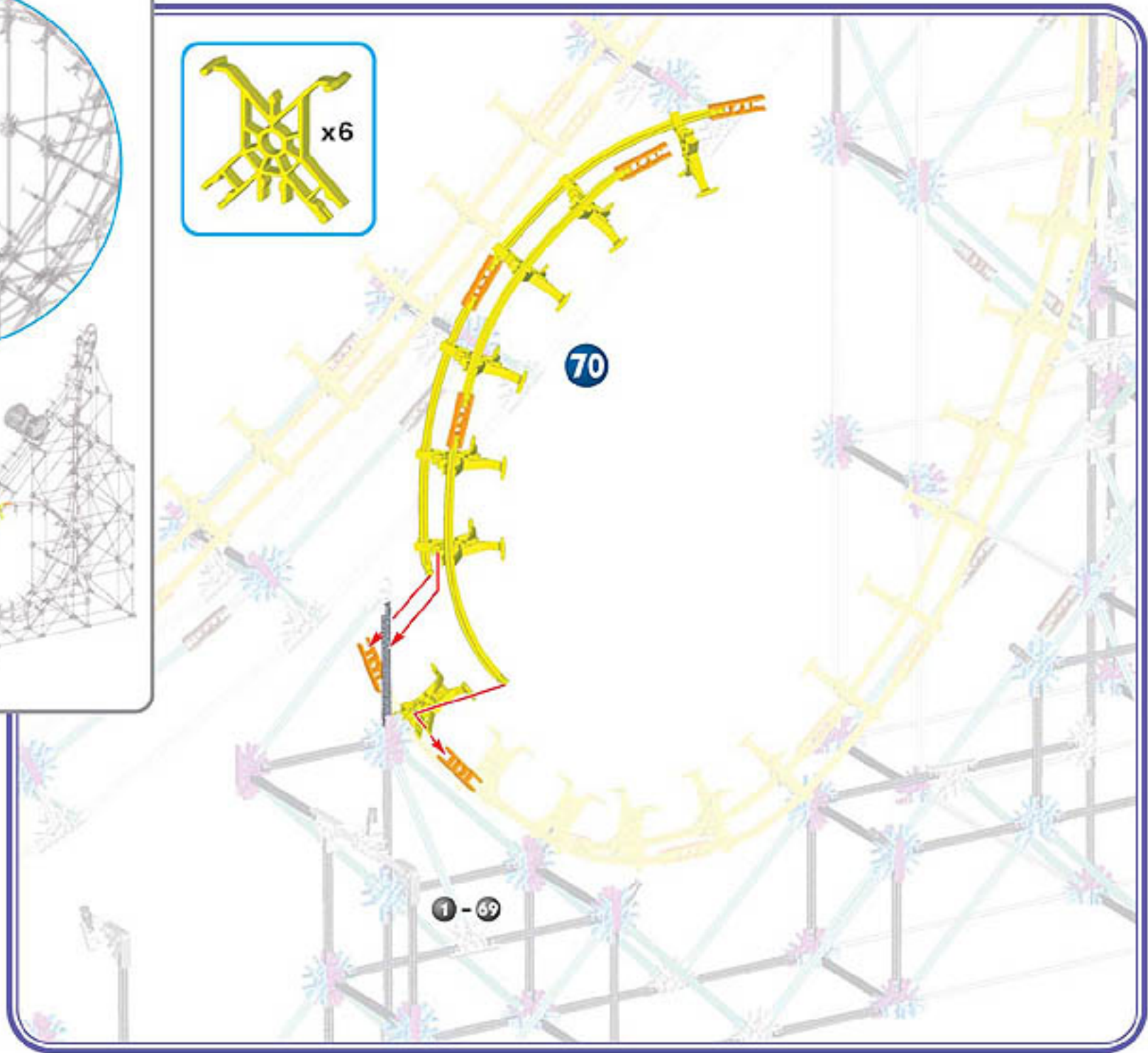
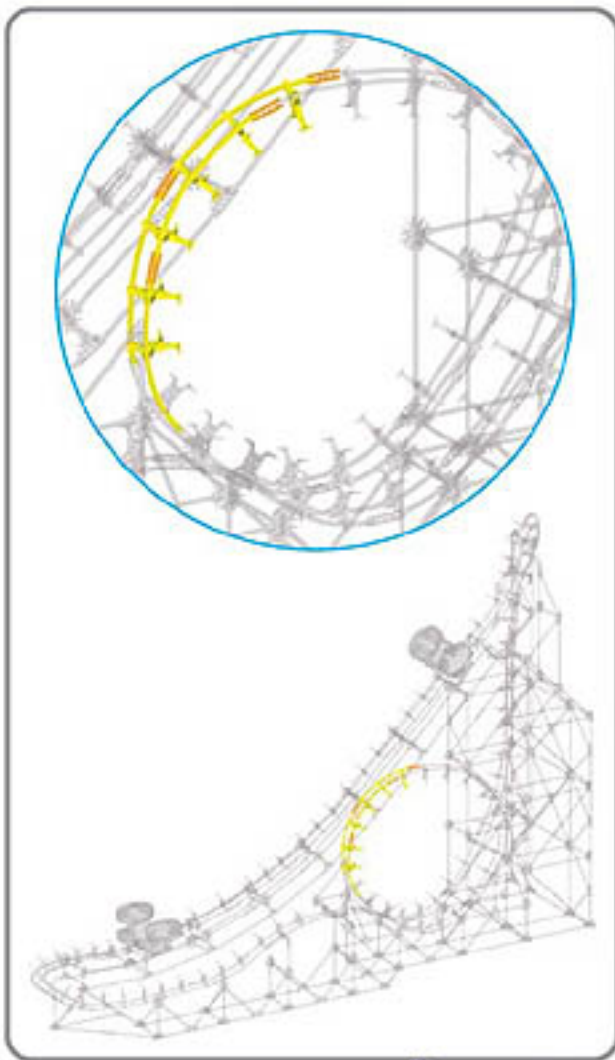

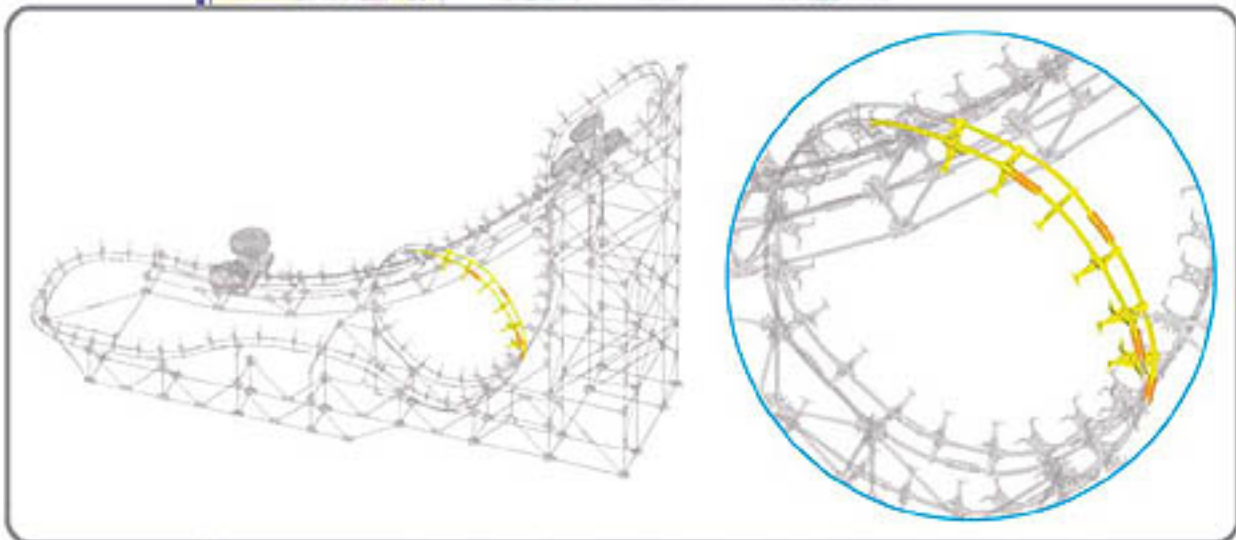
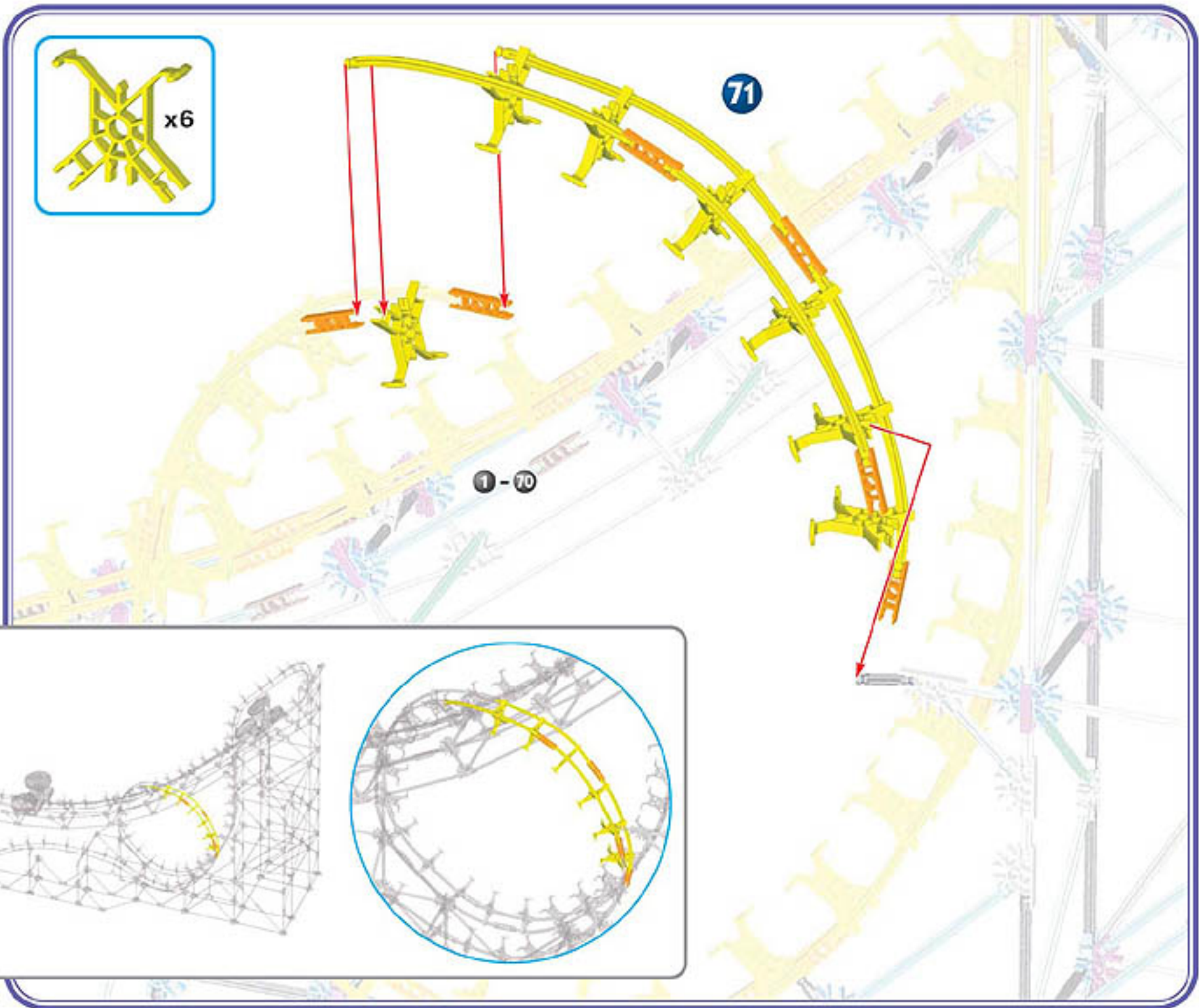

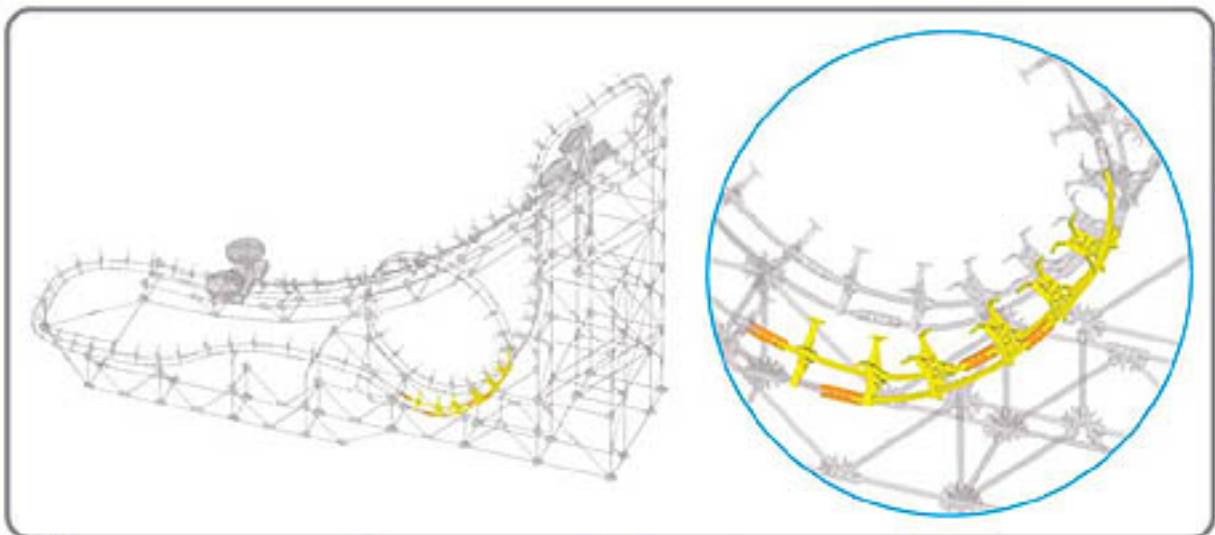

72

1-71

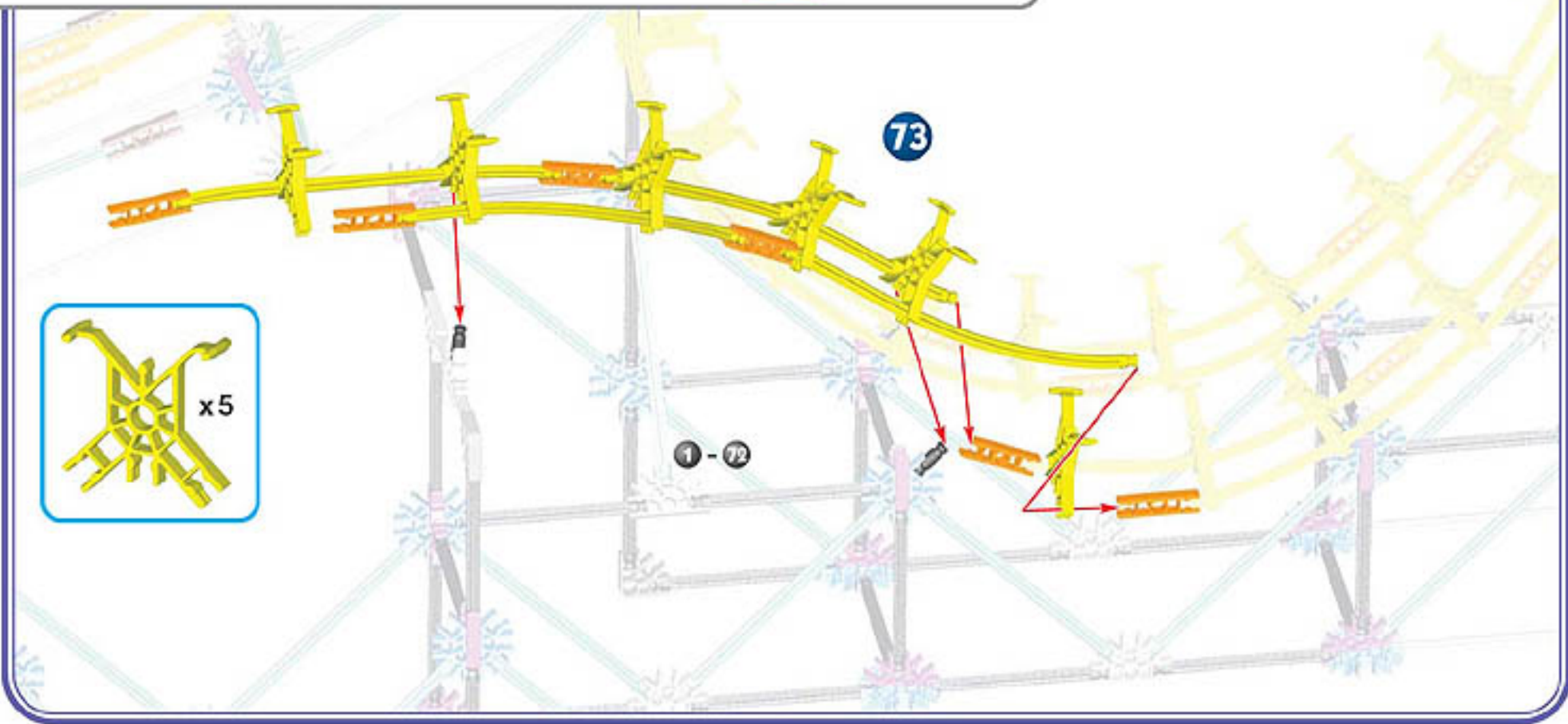
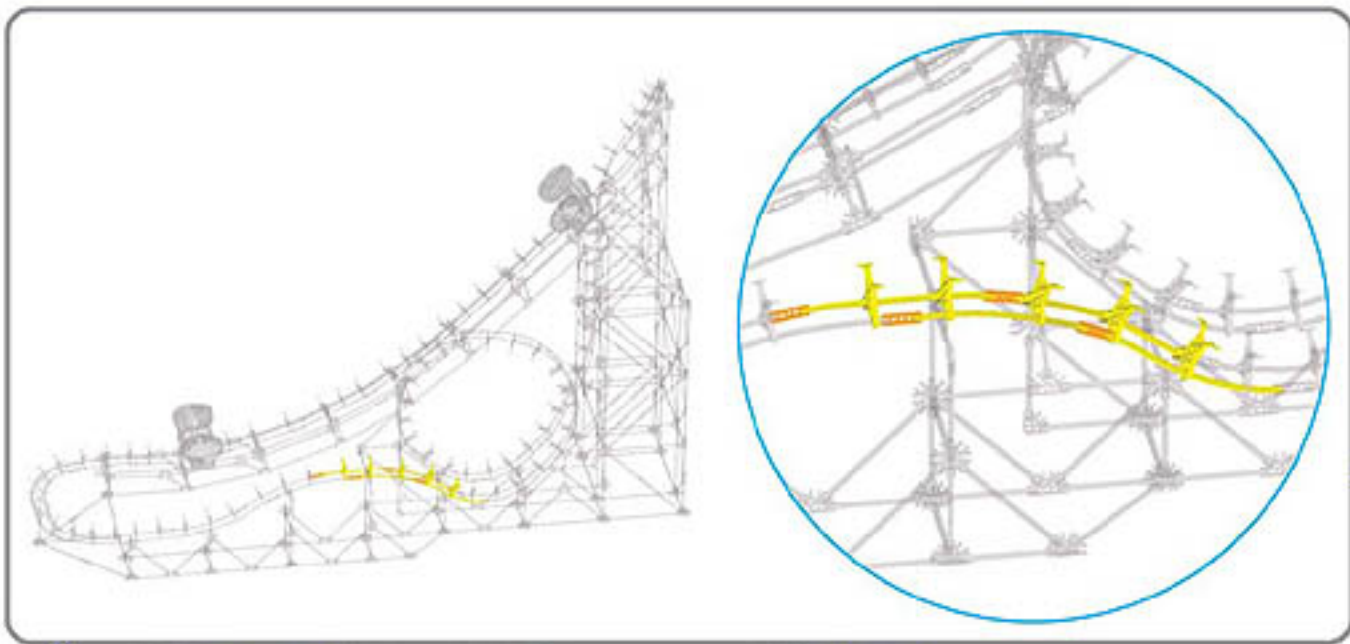

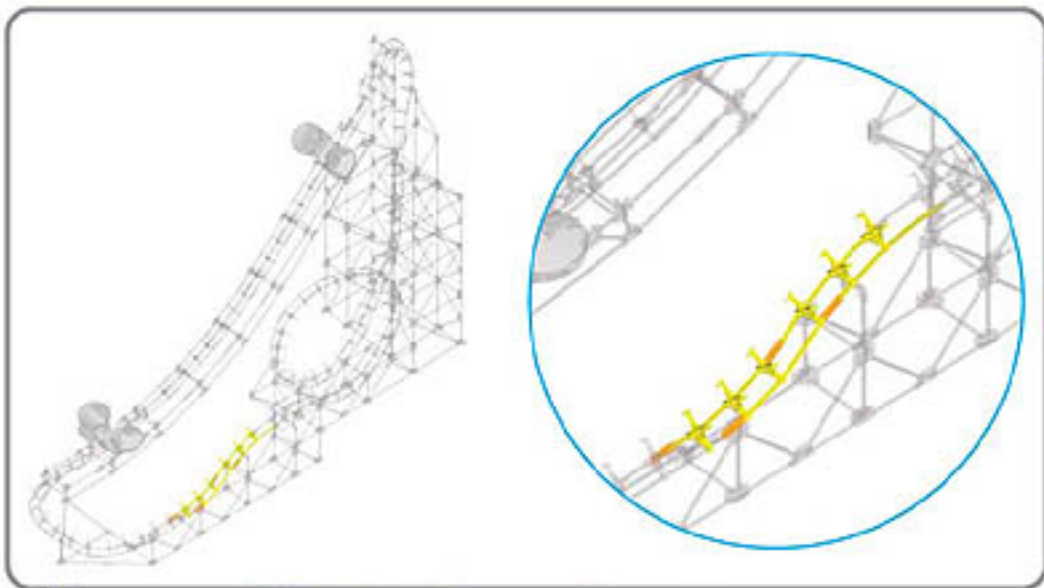

74

1-73

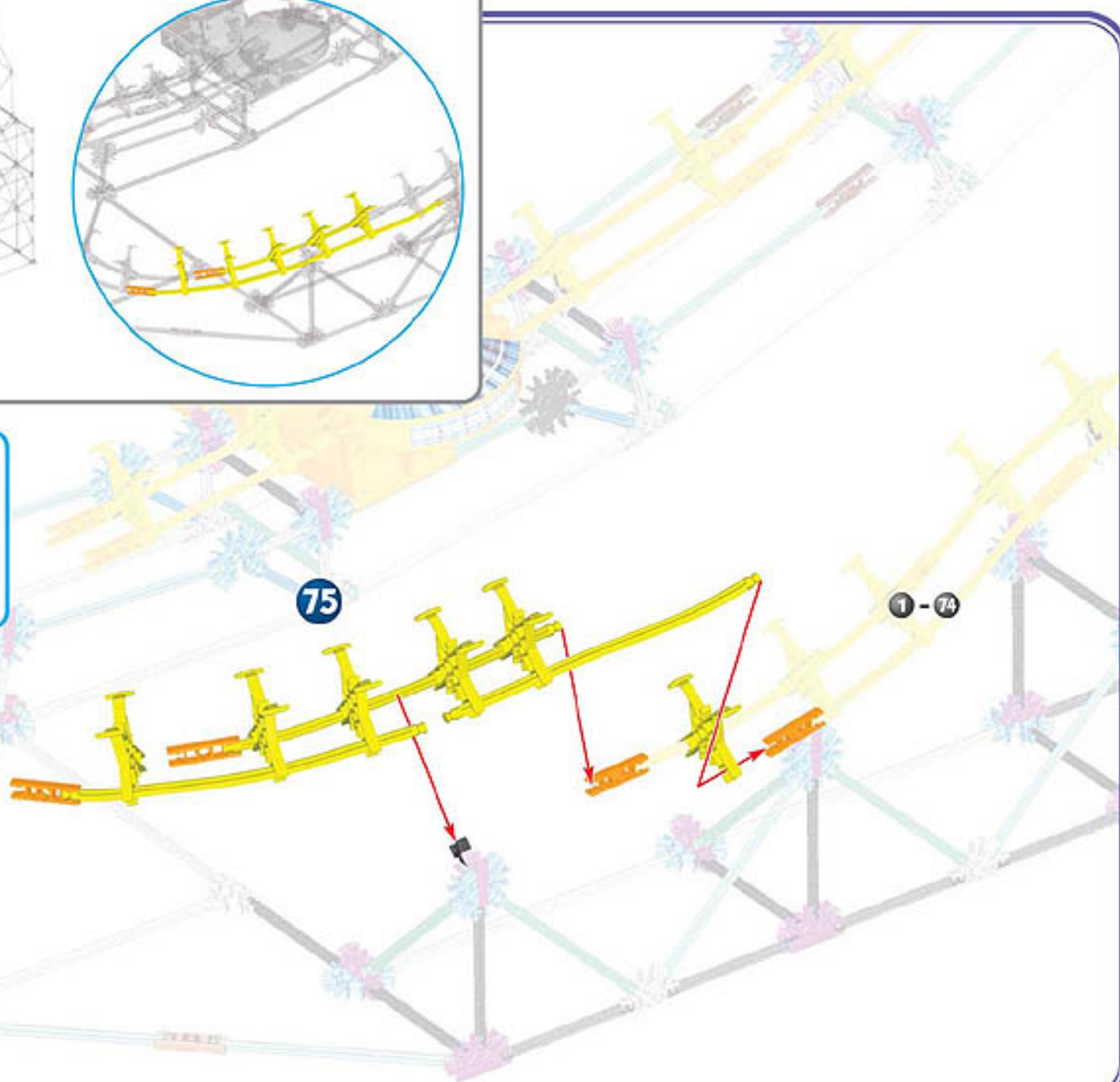
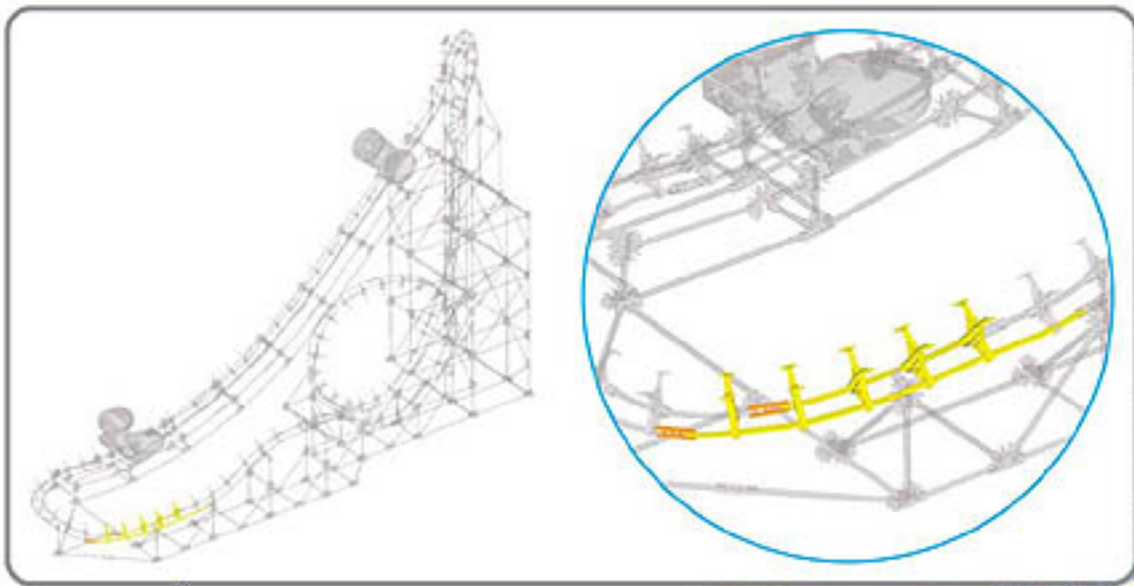

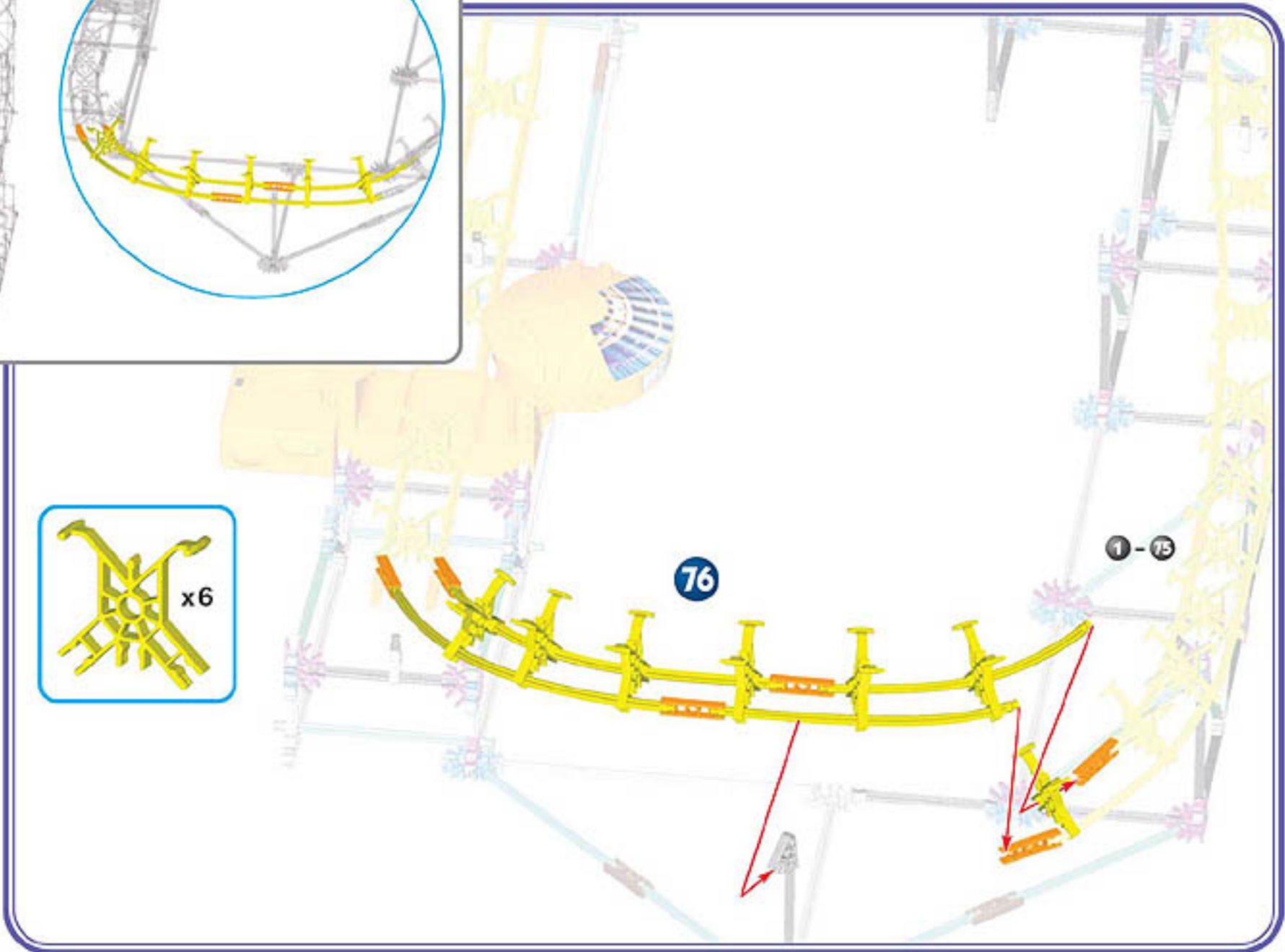
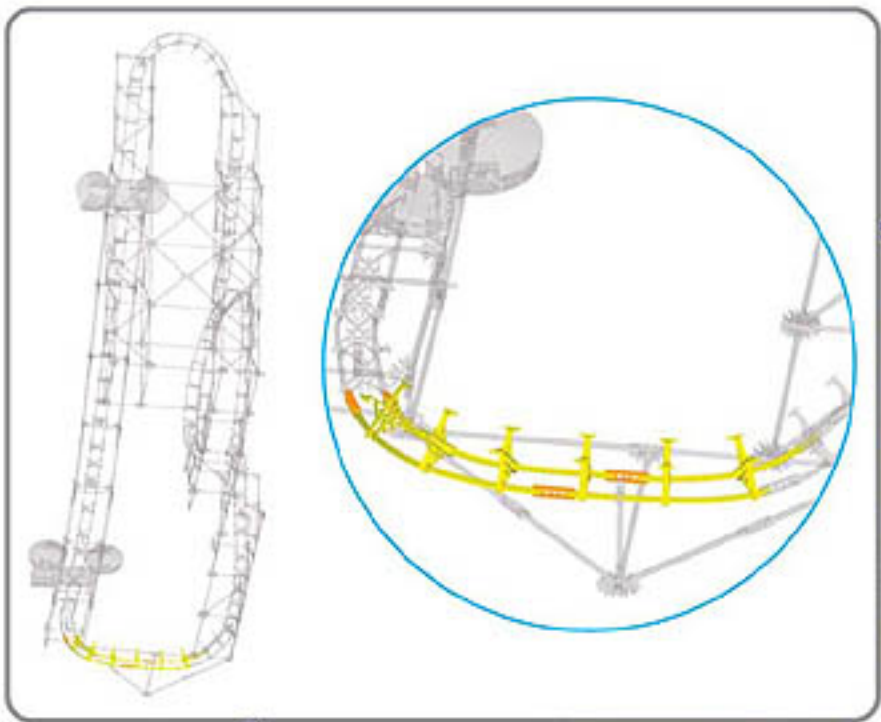



77

1 - 76

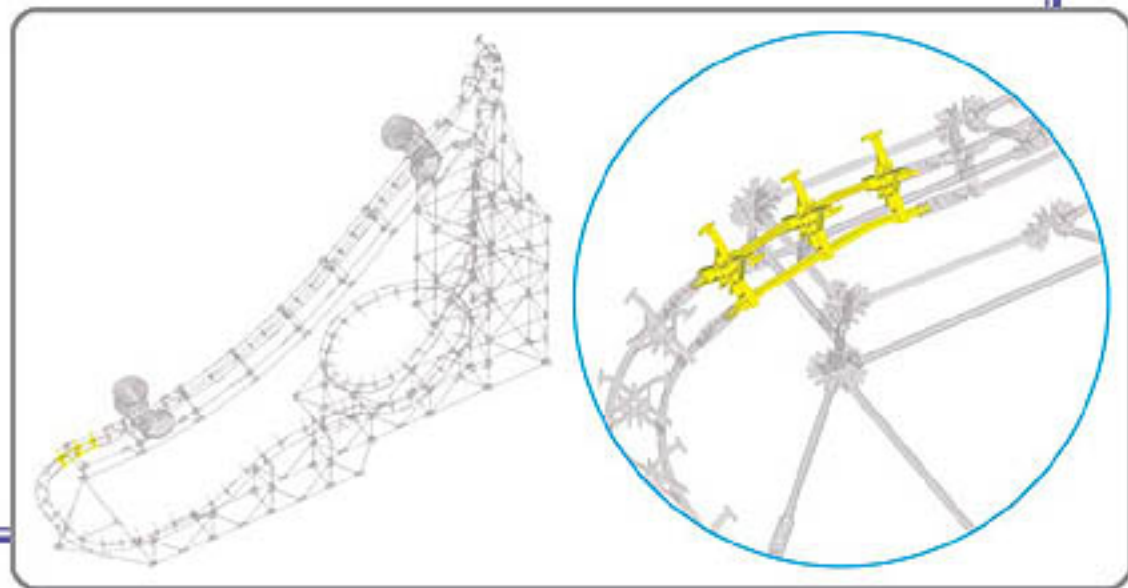



Now it's time to put on both sides of the Track!

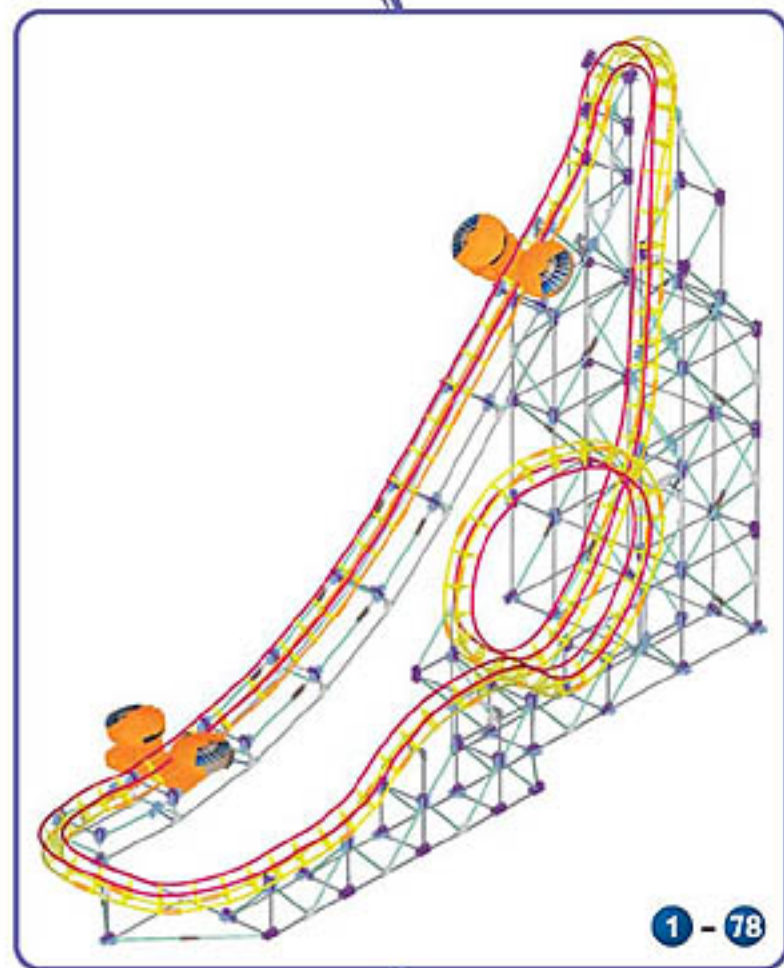
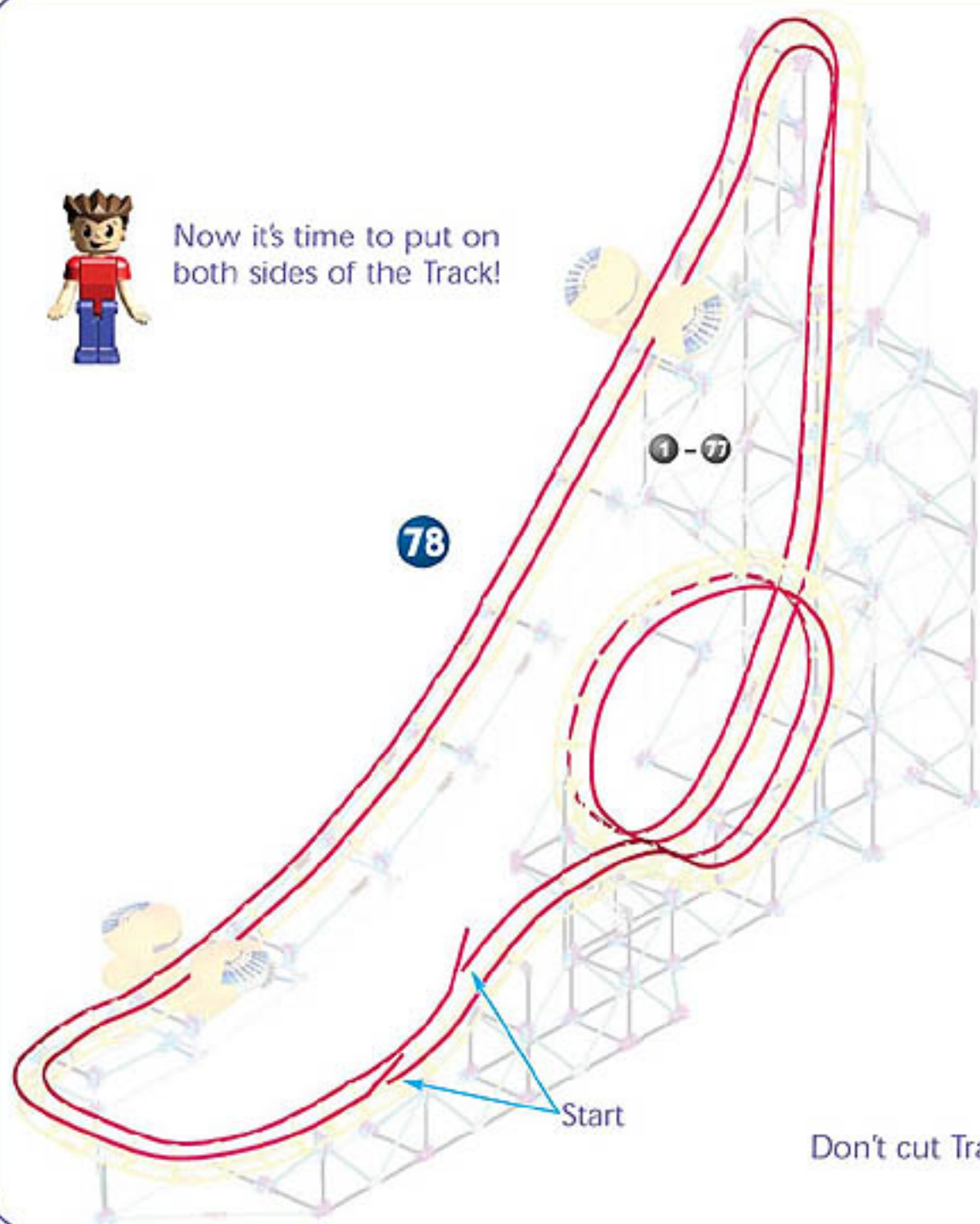

Don't cut Track yet.

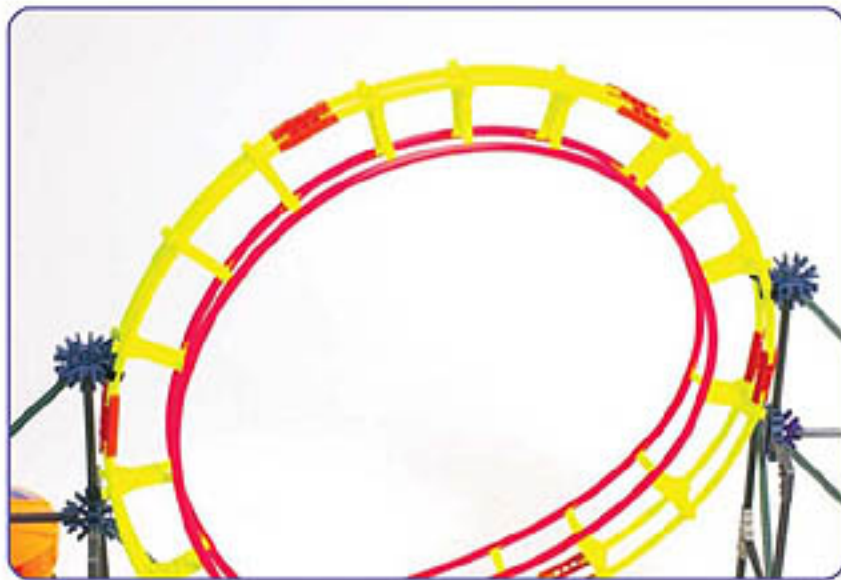

It's important to smooth out the Track, especially in the loop area, before you finally cut the Track.



To attach rocket car, squeeze the Track together and put one side of the car on first, then the other side.



Use sharp scissors to cut the Track as shown.
(Adult help is recommended)

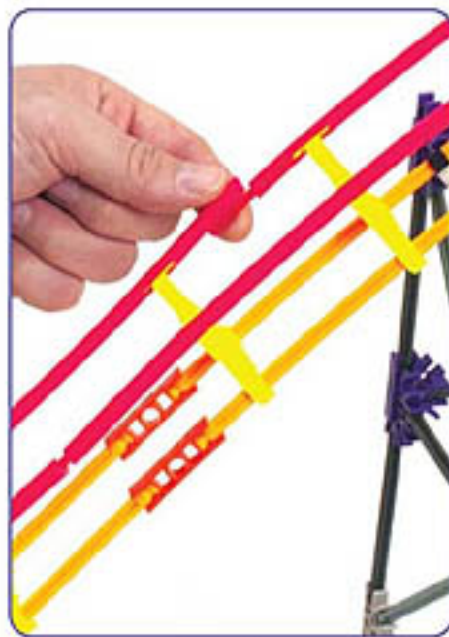

Use a splicer to connect the ends of the track.

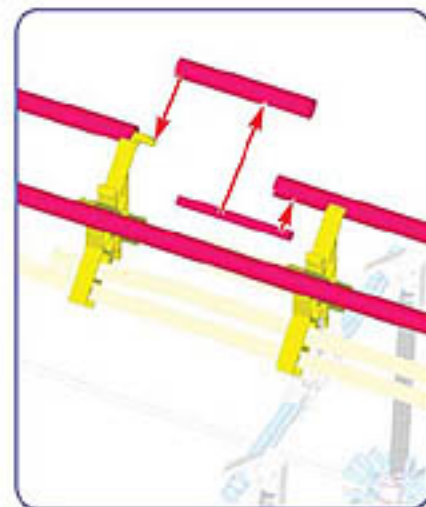

If you cut the Track too short, cut a little more off and then cut a filler piece of Track and splice them together.



For additional tips and troubleshooting information, see page 71 of the RIPPIN' ROCKET instructions book.